

UNIVERSITY OF MINNESOTA



**INTELLIGENT
TRANSPORTATION
SYSTEMS
INSTITUTE**

**I-494 Future Improvements Evaluation
with Two Traffic Simulators**

Final Report

Prepared by:
Haifeng Xiao
Ravi Ambadipudi
John Hourdakis
Panos Michalopoulos

Department of Civil Engineering
University of Minnesota

CTS 05-04

Technical Report Documentation Page

1. Report No. CTS 05-04	2.	3. Recipients Accession No.	
4. Title and Subtitle I-494 Future Improvements Evaluation with Two Traffic Simulators		5. Report Date May 2005	
		6.	
7. Author(s) Haifeng Xiao, Ravi Ambadipudi, John Hourdakis Panos Michalopoulos		8. Performing Organization Report No.	
9. Performing Organization Name and Address University of Minnesota Department of Civil Engineering 500 Pillsbury Drive S.E. Minneapolis, MN 55455-0116		10. Project/Task/Work Unit No. CTS Project number 2003047	
		11. Contract (C) or Grant (G) No.	
12. Sponsoring Organization Name and Address Intelligent Transportation Systems Institute Center for Transportation Studies 511 Washington Avenue SE, Suite 200 Minneapolis, MN 55455		13. Type of Report and Period Covered Final Report	
		14. Sponsoring Agency Code	
15. Supplementary Notes http://www.cts.umn.edu/pdf/CTS-05-04.pdf			
16. Abstract (Limit: 200 words) <p>In anticipation of increased traffic, many transportation agencies endeavor to redesign traffic networks to improve operational efficiency. These agencies frequently employ the strategy of increasing overall capacity. Field-testing for predicted outcomes of these improvements is usually unwieldy and inaccurate. Increasingly, highway design professionals depend on the use of simulation models to predict the consequences of their proposals. The primary advantage of simulation models in the analysis of a complex system is that models are capable of capturing the interactive effects of different components in the system.</p> <p>These authors have evaluated a proposed redesign of a section of the I-494 corridor using two state-of-the-art microscopic simulators—AIMSUN and VISSIM. Results are compared by assessing differences in the outcomes of the two systems and an assessment as to whether they result in similar or measurably different conclusions.</p>			
17. Document Analysis/Descriptors Traffic Simulators I-494		Field-testing AIMSUN VISSIM	18. Availability Statement No restrictions. Document available from: National Technical Information Services, Springfield, Virginia 22161
19. Security Class (this report) Unclassified	20. Security Class (this page) Unclassified	21. No. of Pages 68	22. Price

I-494 Future Improvements Evaluation with Two Traffic Simulators

Final Report

Prepared by:
Haifeng Xiao
Ravi Ambadipudi
John Hourdakis
Panos Michalopoulos

Department Of Civil Engineering
University Of Minnesota

May 2005

Intelligent Transportation Systems Institute
University of Minnesota

CTS 05-04

Acknowledgements

The author(s) wish to recognize those who made this research possible. This study was funded by the Intelligent Transportation Systems Institute (ITS), University of Minnesota. The ITS Institute is a federally funded program administered through the Research & Innovative Technology Administration (RITA).

Table of Contents

CHAPTER 1. INTRODUCTION.....	1
CHAPTER 2. MAJOR CHALLENGES.....	3
2.1 Geometric Coding.....	3
2.2 Demand Data Estimation.....	4
2.2.1 Freeway Demands.....	4
2.2.2 Intersection Demands.....	5
2.3 Demand Data Entry.....	9
2.4 Signal Control Plans.....	9
2.5 Output Extraction.....	10
2.5.1 MOEs Required By MN/DOT.....	10
2.5.2 Data Extraction in AIMSUN.....	11
2.5.3 Data Extraction in VISSIM.....	14
CHAPTER 3. RESULTS AND FINDINGS.....	18
CHAPTER 4. CONCLUSIONS.....	21
APPENDICES	
A. Presentation.....	A-1

List of Figures

Figure 1a	Schematic for the Study Site (Existing Design).....	6
Figure 1b	Schematic for the Study Site (Future Design).....	22
Figure 2a	Segment LOS Obtained from AIMSUN and VISSIM (EBL Road—TH100).....	23
Figure 2b	Segment LOS Obtained from AIMSUN and VISSIM (France Ave—Penn Ave).....	24
Figure 2c	Segment LOS Obtained from AIMSUN and VISSIM (I-35W).....	25
Figure 2d	Segment LOS Obtained from AIMSUN and VISSIM (Portland Ave—TH77).....	26
Figure 2e	Segment LOS Obtained from AIMSUN and VISSIM (24th Ave—34th Ave).....	27
Figure 3a	Intersection LOS Obtained from AIMSUN and VISSIM (EBL Road).....	28
Figure 3b	Intersection LOS Obtained from AIMSUN and VISSIM (France Ave, Penn Ave).....	29
Figure 3c	Intersection LOS Obtained from AIMSUN and VISSIM (Lynd Ave, 76th Str. and 82nd Str)....	30
Figure 3d	Intersection LOS Obtained from AIMSUN and VISSIM (Portland Ave).....	31
Figure 3e	Intersection LOS Obtained from AIMSUN and VISSIM (24th Ave, 34th Ave).....	32

List of Tables

Table 1	Hourly MOEs and LOS for the Segments of EB I-494 (AIMSUN).....	33
Table 2	Hourly MOEs and LOS for the Segments of WB I-494 (AIMSUN).....	34
Table 3	Hourly MOEs and LOS for the Segments of NB I-35W (AIMSUN).....	35
Table 4	Hourly MOEs and LOS for the Segments of SB I-35W (AIMSUN).....	36
Table 5	Hourly MOEs and LOS for the arterial sections (EBL Road, AIMSUN).....	37
Table 6	Hourly MOEs and LOS for Intersection Approaches (AIMSUN).....	37
Table 7	Hourly Overall MOEs and LOS for Signalized Intersections (AIMSUN).....	38
Table 8	Hourly MOEs and LOS for the Segments of EB I-494 (VISSIM).....	39
Table 9	Hourly MOEs and LOS for the Segments of WB I-494 (VISSIM).....	40
Table 10	Hourly MOEs and LOS for the Segments of NB I-35W (VISSIM).....	41
Table 11	Hourly MOEs and LOS for the Segments of SB I-35W (VISSIM).....	42
Table 12	Hourly MOEs and LOS for the arterial sections (EBL Road, VISSIM).....	43
Table 13	Hourly MOEs and LOS for Intersection Approaches (VISSIM).....	44
Table 14	Hourly Overall MOEs and LOS for Signalized Intersections (VISSIM).....	45
Table 15	MOEs for the freeway corridors under consideration.....	46
Table 16	Intersection Delays and LOS.....	47
Table 17	Intersection Delays and LOS.....	48

Executive Summary

With the increase in traffic on road networks the focus of transportation projects has shifted to improving operational efficiency of existing networks. However, the scope of such improvements is limited and may not serve the needs of ever increasing traffic. In anticipation of substantial growth of traffic in coming years many transportation agencies frequently undertake projects which aim to increase the capacity of the system. Federal regulations require that all such changes to existing system be checked for operational efficiency before field implementation. Due to several limitations of the methodologies suggested in HCM, simulation is being employed increasingly for testing selecting/evaluating alternative highway designs. The main advantage of using simulation models in the analysis of a complex system is that the models are capable of capturing the interactive effects of different components of the system. Moreover, the period of analysis can be split into several time slices allowing the user to observe and evaluate the buildup, dissipation and duration of traffic congestion. However, these advantages come at the cost of the large data requirements, the time required for calibration and output processing. Before proceeding to use simulation one needs to select a simulator that meets the requirements of the project at hand or for adapting the most appropriate simulation model for his general needs. Due to the limitations of the simulators and due to the recent emergence of several high performance simulators some state agencies such as Mn/DOT have had insufficient time, money or resources to adapt such a simulator for this purpose. Meanwhile they had a pressing need to evaluate a specific redesign for a freeway corridor in order to obtain federal funds. There was a concern among practitioners about the application of a single model to make decision on the design. Two State-of-the-Art microscopic simulators AIMSUN and VISSIM were used for evaluating a proposed redesign.

The site being redesigned is a section of the I-494 corridor located in the southwestern suburban of the Twin Cities metropolitan area. The study area has two freeways, I-494 spanning in the East-West direction and I-35W spanning in the North-South direction, and 11 signalized intersections. Of the 11 signalized intersections 4 are single point urban interchanges (SPUI). A distinguishing feature of the proposed design when compared to the existing design is the removal of cloverleaf sections on the freeways and the use of SPUI instead of diamond interchanges on the arterials.

The aim of this study is to estimate the adequacy of a new design using simulation. Different MOEs were extracted from the output provided by these models. The results show that the differences between basic MOEs like volumes, speed, density and travel time are similar with both models. However, substantial differences between the two models were observed when it comes to estimating total delay and total number of stops. The discrepancies are mostly due to a difference in definition of some measures.

These results demonstrate the fact that some measures can be different with models for the same constraints. If only one model were applied the user is likely to accept the results unless graphic simulation displayed unusual results. Therefore before making a judgment on the adequacy of a design, one has to ensure the reliability and applicability of model to a particular scenario. Calibration of model parameters plays an important role in determining reliability of the model. A model that gives a reasonable accuracy and is able to simulate all the features of interest should be used while determining adequacy of a future design.

Chapter 1 – Introduction

With the increase in traffic on road networks, the focus of transportation projects has shifted to improving operational efficiency of existing networks. However, the scope of such improvements is limited and may not serve the needs of ever increasing traffic. In anticipation of substantial growth of traffic in coming years, many transportation agencies frequently undertake projects, which aim to increase the capacity of the system. Federal regulations require that all such changes to existing system be checked for operational efficiency before field implementation. Due to several limitations of the methodologies suggested in the Highway Capacity Manual (HCM), simulation is being employed increasingly for testing selecting/evaluating alternative highway designs. The main advantage of using simulation models in the analysis of a complex system is that the models are capable of capturing the interactive effects of different components of the system. Moreover, the period of analysis can be split into several time slices allowing the user to observe and evaluate the buildup, dissipation and duration of traffic congestion. However, these advantages come at the cost of the large data requirements, the time required for calibration, and output processing. Before proceeding to use simulation, one needs to select a simulator that meets the requirements of the project at hand or for adapting the most appropriate simulation model for his/her general needs. Due to the limitations of the simulators and due to the recent emergence of several high-performance simulators, some state agencies such as the Minnesota Department of Transportation (Mn/DOT) have had insufficient time, money or resources to adapt such a simulator for this purpose. Meanwhile they had a pressing need to evaluate a specific redesign for a freeway corridor in order to obtain federal funds. There was a concern among practitioners about the application of a single model to make decision on the design. Two state-of-the-art microscopic simulators AIMSUN and VISSIM were used for evaluating a proposed redesign.

The site being redesigned is a section of the I-494 corridor located in the southwestern suburban of the Twin Cities metropolitan area. Figure 1 in the appendix shows a schematic representation of the existing and future geometries. Also shown in the figure are the differences between the two geometries. As figure 1 suggests the study

area has two freeways, I-494 spanning in the East-West direction and I-35W spanning in the North-South direction, and 11 signalized intersections. Of the 11 signalized intersections, 4 are single-point urban interchanges (SPUI). A distinguishing feature of the proposed design when compared to the existing design is the removal of cloverleaf sections on the freeways and the use of SPUI instead of diamond interchanges on the arterials.

This report presents some of the major issues and challenges encountered in the modeling process with two simulators, followed by their results. The results are compared not only for assessing differences but also for checking whether they result in similar or radically different conclusions in decision making.

Chapter 2 - Major Challenges

As microscopic simulation needs input data including geometry, demand, and control plans to be coded in the formats required by the models in very detail, the preparation and/or entry of these data are the challenges in the modeling process. The extraction of output data from microscopic simulators is usually also an issue mainly due to the fact that Measures of Effectiveness (MOEs) produced in the simulators do not always meet users' needs for specific projects and thus extra effort is necessary. These challenges become more substantial as modeling networks becoming larger. This section discusses the challenges encountered in the I-494 modeling projects.

2.1 Geometry Coding

- Background maps: To replicate the I-494 redesign in the models, both AIMSUN and VISSIM require scaled maps as background for geometry coding. In the study, the future redesign blueprints were in the format of Microstation files provided by Mn/DOT. They were not acceptable for both simulators and thus needed to be converted. Background maps are not clear enough after they are converted into Bitmap files for VISSIM and DXF files for AIMSUN. Double-check of the design on larger-scale maps was conducted to identify the critical points (lane-drop, on/off ramps) and numbers of lanes.
- Geometry edits: Although both simulators provide graphical interface that makes the geometry coding much easier, it is relatively difficult to make changes on the existing geometrics in both simulators once they are built. For instance, moving multiple objects is not possible in VISSIM, while curving a section is impossible in AIMSUN. Experience is absolutely necessary and additional attention needs to be paid while building geometry in both simulators to reduce extra effort on changes on geometry.

2.2 Demand Data Estimation

To simulate the build-year case in a microscopic simulator, we need demands at entry points and turning proportions at decision-making points. This implies that we need to know the traffic counts expected at every 15-minute interval on every segment of the network for the build-year. These data is usually not available from traffic forecast planning models and thus need to be estimated for microscopic simulation purposes. The process of data estimation may be time-consuming and challenging, depending on the quality of the data available. Generally speaking, data balancing is most challenging in the process when different and/or incomplete data sets are used for estimation. Some assumptions have to be made in order to reduce computation workload.

This issue was also encountered in this study. The data that was made available to enable the demand estimation for the build-year (2017) is as following:

- Current and build year (2017) geometries;
- Loop detector data in the form of 15 minute-interval traffic counts for I-494 between East Bush Lake road and TH-5 and for I-35W between 90th Street and 66th Street on five different days in the year 2001;
- Build-year AM, PM peak hour and Average Annual Daily Traffic (AADT) data for different segments on the freeway;
- Intersection demands and turning movements for all the intersections included in the geometries between 6:00 am – 9:00 am and 3:00 pm – 6:00 pm for the current and build year.

2.2.1 Freeway Demands

It was observed that there are many differences between the current and the build-year geometries. For example, the build-year geometry has fewer weaving sections and different merge and exit points from the freeway when compared to the current geometry. The removal of the weaving sections resulted in long mainline segments. It was also observed that some new on-ramps and off-ramps are proposed for the build year.

Due to the aforementioned changes to the geometry of the current conditions, one cannot simply use a factor to get the demands on various segments for the build-year. To account for the geometry changes and lack of data in some locations, the estimation process was split into the following cases:

1. Estimation of demands for links which exist in both the geometries
2. Estimation of demands for links which exist only in the geometry of the build year.

Case 1:

The mainline of the build-year differs considerably from the current conditions. So most of the links which exist in both the geometries were observed to be either on-ramp or off-ramp links with minor changes. For these links the 15-minute interval demand data for the year 2017 was obtained by multiplying the current demand data with the ratio of 2017 AADT to current AADT.

Case 2:

- A. Where possible, conservation equation is used to estimate the demands
- B. If a link branches into two, and the use of conservation equation is not possible, the demands of that link are distributed into the branches in the ratio of their AADT's.

In all the cases it is ensured that the mainline volumes are balanced using conservation equation, and the balancing is done beginning from the upstream of the freeway. It is assumed that the resulting capacity problems will be handled by the simulator used.

2.2.2 Intersection Demands

Once the freeway mainline data is balanced with respect to entering and exiting demands, the intersection demands can be estimated. In this part, the data for the traffic that goes on to the on-ramps from the intersection and the traffic that comes onto the intersection from an off-ramp will be adjusted so that it equals the estimated demand of an on/off ramp for each time splice.

For the year 2017, the 15-minute estimated volumes and turning counts on different links of the intersection were provided by the DOT. However, these counts do not match the estimated counts on the entrances and exits. Therefore the intersection data was balanced so that it equals the estimated data of on-ramps and off-ramps.

The following figure shows a typical intersection area.

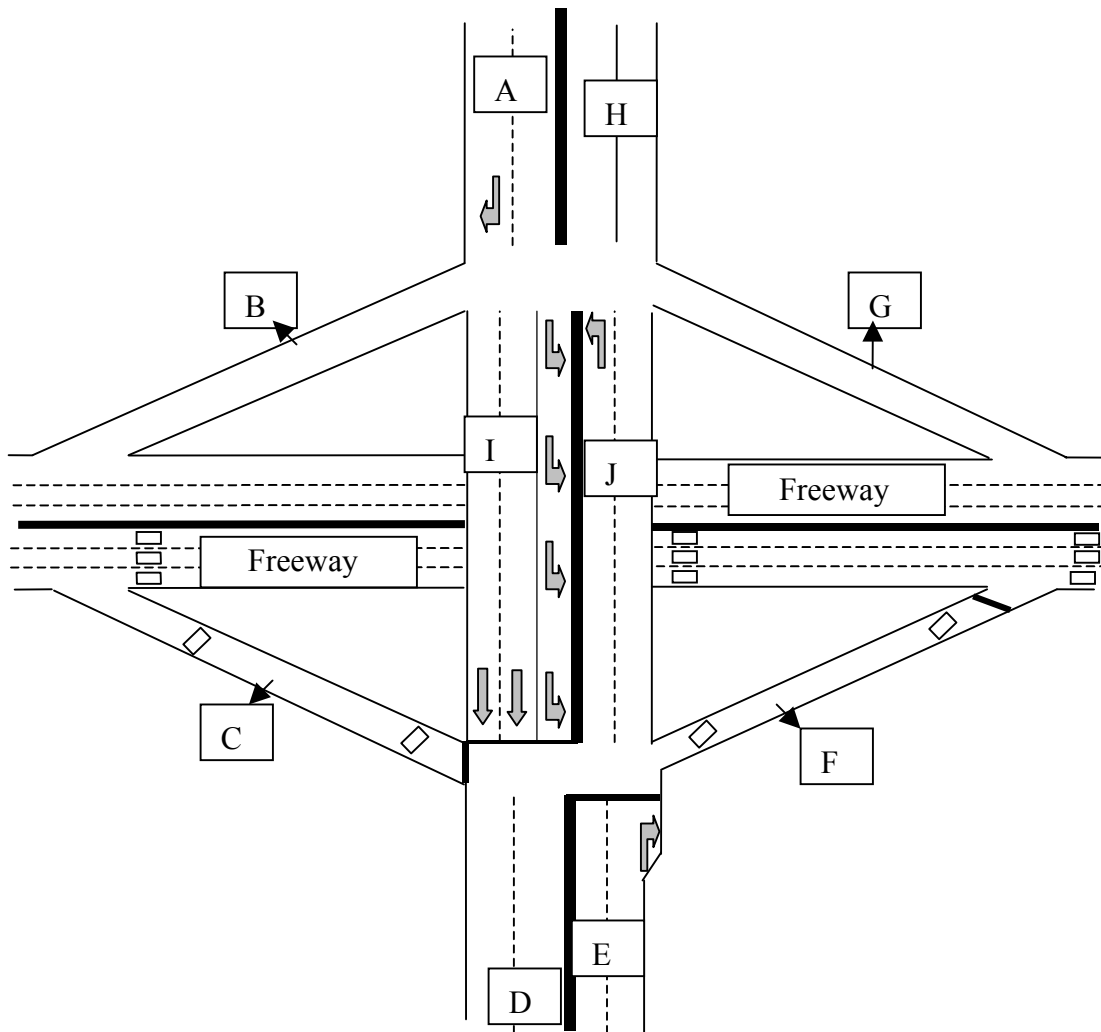

Figure 1: A typical diamond interchange

The assumptions made during the balancing of intersection volumes are following:

- Vehicles from an off-ramp section do not enter any on-ramp section.
- Sum of left-turn vehicles from section J and right-turn vehicles on section A equals the vehicle count on section B
- Sum of left-turn vehicles from section I and right-turn vehicles on section E equals the vehicle count on section F
- Sum of right-turn vehicles on section C and through vehicles from section I equal the vehicle count on D
- Sum of left-turn vehicles on section C and through vehicles from section E equal the vehicle count on J
- Intersection signalization has no effect
- For the intersection shown in figure 1, the following equations can be developed to balance the data:
- Balancing the flow for on-ramp section B

$$(B / (A_p^R + J_p^L)) * A_p^R = A^R (E)$$

$$(B / (A_p^R + J_p^L)) * J_p^L = J^L (E) \text{ or } B - A^R (E) = J^L (E)$$

Where,

B is the estimated 15-minute demand on onramp B
 A_p^R is the 2017 right-turn count on link A provided by DOT
 J_p^L is the 2017 left-turn count on link J provided by DOT
 $A^R (E)$ is the balanced right-turn count on link A for 2017
 $J^L (E)$ is the balanced left-turn count on link J for 2017

- Balancing the flow for on-ramp section F

$$(F / (E_p^R + I_p^L)) * E_p^R = E^R (E)$$

$$(F / (E_p^R + I_p^L)) * I_p^L = I^L (E)$$

Where,

F is the estimated 15-minute demand on onramp F
 E_p^R is the 2017 right-turn count on link E provided by DOT
 I_p^L is the 2017 left-turn count on link I provided by DOT
 $E^R (E)$ is the balanced right-turn count on link E for 2017
 $I^L (E)$ is the balanced left-turn count on link I for 2017

- Balancing the flow from the off-ramp G

$$(G / (G_p^R + G_p^L)) * G_p^R = G^R (E)$$

$$(G / (G_p^R + G_p^L)) * G_p^L = G^L (E)$$

Where,

G is the estimated 15-minute demand on off ramp G

G_p^R is the 2017 right-turn count on link G provided by DOT

G_p^L is the 2017 left-turn count on link G provided by DOT

$G^R (E)$ is the balanced right-turn count on link G for 2017

$G^L (E)$ is the balanced left-turn count on link G for 2017

- Balancing the flow from the off-ramp C

$$(C / (C_p^R + C_p^L)) * C_p^R = C^R (E)$$

$$(C / (C_p^R + C_p^L)) * C_p^L = C^L (E)$$

Where,

C is the estimated 15-minute demand on off-ramp C

C_p^R is the 2017 right-turn count on link C provided by DOT

C_p^L is the 2017 left-turn count on link C provided by DOT

$C^R (E)$ is the balanced right-turn count on link C for 2017

$C^L (E)$ is the balanced left-turn count on link C for 2017

- The remaining data for the intersections can be computed using the following equations

$$C^L (E) + E_p^T - J^L (E) = J^T (E)$$

$$G^L (E) + A_p^T - I^L (E) = I^T (E)$$

$$A_p^T + A^R (E) = A (E)$$

$$E_p^T + E^R (E) = E (E)$$

Where,

E_p^T is the 2017 through count on link E provided by DOT

A_p^T is the 2017 through count on link A provided by DOT

A (E) is the balanced volume on link A for 2017

E (E) is the balanced volume on link E for 2017

- Similar assumptions and formulas were used for estimating demands at single point urban interchanges.

2.3 Demand Data Entry

As no appropriate tools are available at present, the process of demand data entry is extremely time consuming for both simulators and is prone to errors. As many as 8000 data entries needed to be entered manually for each simulator. Some input errors were unknown till discrepancies were found in the process of output extraction.

Specifically, it is not uncommon to adjust decision points for turning at exit links when unrealistic vehicle behavior is observed in VISSIM. The adjustment usually requires the definition of previous routes be deleted and new ones be set up again. This process is also time-consuming.

2.4 Signal control plans

Although both AIMSUN and VISSIM (version 7.0) provide interfaces to Synchro files, initial configurations including phases and corresponding movements are still needed. It is not advantageous when pre-timed control plans are used for simulations. We didn't implement this interfacing function in the modeling process as pre-timed control plans were eventually used for both intersections and ramp meters. Instead, signal control plans at signalized intersections for the design year (2017) are optimized using Synchro and manually input in the two simulators. Metering rates at ramps were estimated based on historical data and adjusted in the modeling process when unrealistic congestions were observed on the ramps or neighboring freeway mainline.

It should be noted that VISSIM doesn't directly have an option for ramp metering, thus two-phase pre-timed control plans were used as work around. Besides, VISSIM accepts only integers for green, red and amber times in signal control plans. Decimal time periods for metering control plan were rounded up to whole seconds.

2.5 Output Extraction

Another major challenge in the modeling process is output extraction. At present, no streamline process tools are available for users to directly obtain MOEs in the formats required by Mn/DOT from the simulators. Volumes, Speeds, Densities and LOS for segments and delays for overall intersections that are of interest to MN/DOT are not available directly as an output from the models. Reference tables that contain segments and their corresponding sections had to be built manually and then queries in MS Access were created in order to obtain the MOEs of interest.

In this study, this process was time-consuming mainly because it took several hours to obtain MOEs in the required formats. Simulations need to rerun when errors were found and unrealistic driving behaviors were observed.

2.5.1 MOEs Required by MN/DOT

The MOEs required by MN/DOT can be divided into two groups, respectively for freeways and arterial intersections. The MOEs for freeways are hourly volumes, speeds, densities and Level Of Service (LOS) for each segment on mainlines and ramps. Total throughput of actual volume vs. simulated volumes and differences are also reported. The MOEs for intersections are delays and LOS for intersections as a whole and approach as well as the hourly volumes, speeds, densities and LOS for each arterial section. All the MOEs should be aggregated at hourly levels based on 15 minutes increment. The simulation period is from 3:00 pm to 6:00 pm, consequently, a total of nine hour MOEs need to be collected: 3:00—4:00, 3:15—4:15, ..., till 5:00—6:00. As these MOEs are not directly available in both simulators, they have to be derived using user-developed programs and database queries. Other arterial MOEs include: demand volumes compared to modeled demand and percentage difference, through-link length and queue, and left and right turn storage and queues.

2.5.2 Data extraction in AIMSUN

The basic measures provided in AIMSUN are speeds, densities, volumes, delays, stops, travel times and so on. These measures can be aggregated at section, stream (a sequence of sections), or/and system levels, depending on user-specified needs. In this study, the measures were collected at section level for freeway segments while at stream level for intersections. The time interval of collection is 15 minutes. Once the output file was stored in an Access database, queries were written to derive MOEs in the format required by MN/DOT. A reference table consisting of all the segments and their corresponding section IDs had to be built manually based on the network in AIMSUN.

The MOEs in the format required by MN/DOT can be calculated using the following formulas.

a. Volumes

$$VOL_{i,p} = \sum_{k=p}^{p+4} Vol_{i,k}$$

$VOL_{i,p}$: volume during p^{th} hour on segment i .

$Vol_{i,k}$: volume in time interval k on segment i , and can be calculated as following

$$Vol_{i,k} = \frac{\sum_{j=1}^{n_i} vol_{i,j,k}}{n_i}$$

$Vol_{i,k}$: average volume in time interval k on segment i .

$vol_{i,j,k}$: volume in time interval k on the j^{th} section of segment i .

n_i : the number of sections that segment i has.

b. Speeds

$$SPEED_{i,p} = \frac{\sum_{k=p}^{p+4} Vol_{i,k} \cdot Speed_{i,k}}{\sum_{k=p}^{p+4} Vol_{i,k}}$$

$SPEED_{i,p}$: average speed during p^{th} hour on segment i .

$Vol_{i,k}$: average volume in time interval k on segment i , and calculated as previously.

$Speed_{i,k}$: average speed in time interval k on segment i , can be calculated as following:

$$Speed_{i,k} = \frac{\sum_{j=1}^{n_i} vol_{i,j,k} \cdot speed_{i,j,k}}{\sum_{j=1}^{n_i} vol_{i,j,k}}$$

$Speed_{i,k}$: average speed in time interval k on segment i .

$vol_{i,j,k}$: volume in time interval k on the j^{th} section of segment i .

$speed_{i,j,k}$: average speed in time interval k on the j^{th} section of segment i .

n_i : the number of sections that segment i has.

c. Densities

$$DENSITY_{i,p} = \frac{\sum_{k=p}^{p+4} Vol_{i,k} \cdot Density_{i,k}}{\sum_{k=p}^{p+4} Vol_{i,k}}$$

$DENSITY_{i,p}$: average density during p^{th} hour on segment i .

$Vol_{i,k}$: volume in time interval k on segment i , and calculated as previously.

$Density_{i,k}$: average density in time interval k on segment i , can be calculated as following:

$$Density_{i,k} = \frac{\sum_{j=1}^{n_i} vol_{i,j,k} \cdot density_{i,j,k}}{\sum_{j=1}^{n_i} vol_{i,j,k}}$$

$Density_{i,k}$: average density in time interval k on segment i .

$vol_{i,j,k}$: volume in time interval k on the j^{th} section of segment i .

$density_{i,j,k}$: average density in time interval k on the j^{th} section of segment i .

n_i : the number of sections that segment i has.

d. LOS

AIMSUN does not provide LOS for freeway segments and signalized intersections. Users have to use the model to generate measures to determine the LOS. According to the criteria in HCM, densities are used for determining LOS on freeway segments and control delays are used for signalized intersections.

e. Travel time

$$TRAVEL_{i,p} = \frac{\sum_{k=p}^{p+4} Vol_{i,k} \cdot Travel_{i,k}}{\sum_{k=p}^{p+4} Vol_{i,k}}$$

$TRAVEL_{i,p}$: average travel time per vehicle during p^{th} hour on segment i .

$Vol_{i,k}$: volume in time interval k on segment i , and calculated as previously.

$Travel_{i,k}$: average travel time in time interval k on segment i , can be calculated as following:

$$Trave_{i,k} = \sum_{j=1}^{n_i} travel_{i,j,k}$$

$Travel_{i,k}$: average travel time in time interval k on segment i .

$Travel_{i,j,k}$: average travel time in time interval k on the j^{th} section of segment i .

f. Intersection delays

$$D = \frac{\sum_i d_i \cdot V_i}{\sum_i V_i}$$

D : intersection overall delay.

V_i : through volume at direction i .

d_i : average delay in direction i , and calculated as follows.

$$d_i = \frac{\sum_j d_{i,j} \cdot V_{i,j}}{\sum_j V_{i,j}}$$

d_i : Average delay in direction i.

$d_{i,j}$: Average delay at (stream)approach j in direction i.

$V_{i,j}$: Volume at (stream) approach j in direction i.

2.5.3 Data Extraction in VISSIM

The data extraction process is more complicated in VISSIM than in AIMSUN. Unlike AIMSUN, whose outputs are incorporated into one database file, the outputs of VISSIM are separately stored in different text files. The basic measures provided in link evaluation file are speeds, densities and volumes. In order to obtain travel times and delays for sections, the start and end points of travel time sections have to be defined prior to simulation. A program was developed to combine the output files of links and travel time sections into one file in the format accepted by Microsoft Access. After the file was exported into Access, queries were written to derive MOEs in the format required by MN/DOT. A reference table consisting of all the segments and their corresponding link IDs had also to be built manually based on the network in VISSIM.

a. Volumes

$$VOL_{i,p} = \sum_{k=p}^{p+4} Vol_{i,k}$$

$VOL_{i,p}$: volume during p^{th} hour on travel time section (segment) i.

$Vol_{i,k}$: volume in time interval k on travel time section (segment) i.

b. Speeds

$$SPEED_{i,p} = \frac{\sum_{k=p}^{p+4} Vol_{i,k} \cdot Speed_{i,k}}{\sum_{k=p}^{p+4} Vol_{i,k}}$$

$SPEED_{i,p}$: average speed during p^{th} hour on travel time section (segment) i .

$Vol_{i,k}$: volume in time interval k on travel time section (segment) i .

$Speed_{i,k}$: average speed in time interval k on travel time section (segment) i , can be calculated as following:

$$Speed_{i,k} = \frac{Distance_i}{Travel_{i,k}}$$

$Speed_{i,k}$: average speed in time interval k on travel time section (segment) i .

$Travel_{i,k}$: average travel time in time interval k on travel time section (segment) i .

$Distance_i$: the distance of travel time section (segment) i .

c. Densities

$$DENSITY_{i,p} = \frac{\sum_{k=p}^{p+4} Vol_{i,k} \cdot Density_{i,k}}{\sum_{k=p}^{p+4} Vol_{i,k}}$$

$DENSITY_{i,p}$: average density during p^{th} hour on segment i .

$Vol_{i,k}$: volume in time interval k on segment i , and calculated as previously.

$Density_{i,k}$: average density in time interval k on segment i , can be calculated as following:

$$Density_{i,k} = \frac{\sum_{j=1}^{n_i} vol_{i,j,k} \cdot density_{i,j,k}}{\sum_{j=1}^{n_i} vol_{i,j,k}}$$

$Density_{i,k}$: average density in time interval k on segment i .

$vol_{i,j,k}$: volume in time interval k on the j^{th} section of segment i .

$density_{i,j,k}$: average density in time interval k on the j^{th} section of segment i .

n_i : the number of sections that segment i has.

d. LOS

VISSIM also does not provide LOS for freeway segments and signalized intersections. Users have to use the model to generate measures to determine the LOS. According to the criteria in HCM, densities are used for determining LOS on freeway segments and control delays are used for signalized intersections.

e. Travel time

$$TRAVEL_{i,p} = \frac{\sum_{k=p}^{p+4} Vol_{i,k} \cdot Travel_{i,k}}{\sum_{k=p}^{p+4} Vol_{i,k}}$$

$TRAVEL_{i,p}$: average travel time per vehicle during p^{th} hour on travel time section (segment) i .

$Vol_{i,k}$: volume in time interval k on travel time section (segment) i .

$Travel_{i,k}$: average travel time in time interval k on travel time section (segment) i .

f. Intersection delays

$$D = \frac{\sum_i d_i \cdot V_i}{\sum_i V_i}$$

D : intersection control delay as a whole.

V_i : through volume at direction i .

d_i : average delay in direction i , and calculated as follows.

$$d_i = \frac{\sum_j d_{i,j} \cdot V_{i,j}}{\sum_j V_{i,j}}$$

d_i : Average delay in direction i .

$d_{i,j}$: Average delay at approach (travel time section) j in direction i .

$V_{i,j}$: Volume at approach (travel time section) j in direction i .

Chapter 3 - Results and Findings

As the purpose of this study is to determine the adequacy of a new design using simulation, the analysis was extensive and included MOEs for different links on the entire network. All the final results in this study are the average values for five replications. The hourly MOEs for freeway segments and intersection approaches are tabulated in EXCEL files. Figures 2a through 2e demonstrate the LOS on average in three hours obtained from AIMSUN and VISSIM for segments on freeway mainline and ramps, while figures 3a through 3e for intersection approaches on arterials. Tables 1 through 14 show various hourly MOEs and LOS for the freeway and intersections. In the tables, highlighted rows indicate an LOS difference of at least 2 orders. Table 15 summarizes the design adequacy evaluation results. As can be seen from the table, among a total of 131 freeway links considered, most links perform no worse than LOS E. Furthermore, only six links are at LOS F in AIMSUN while five links in VISSIM. It should be noted that only one link is at LOS F in both AIMSUN and VISSIM. For most cases, AIMSUN and VISSIM can result in similar conclusions in terms of LOS and thus the adequacy of design. As can be seen in the table, only 14 out of 131 links are shown two or more orders in LOS differences between AIMSUN and VISSIM. As for intersection approaches, the table shows that AIMSUN and VISSIM have less consistency in LOS when compared to freeway links. As can be seen among a total of 105 approaches, 14 are at LOS F in AIMSUN while 4 in VISSIM. In addition, 30 out of 105 approaches were shown two or more orders in LOS differences between AIMSUN and VISSIM.

Table 16 shows some system-wide MOEs at different aggregation levels in both simulators. The percentage differences between the observed measures using the two models are also shown in the table. A positive value of percentage difference for an MOE implies that AIMSUN produced higher values as compared to VISSIM. The values suggest that there are some differences in the observed values of total travel, total travel time and speed between the two simulators while the differences between the observed values of total delay, average delay, total number of stops and average number of stops is significant. Although the differences in total travel estimated by both the models are within 10%, it can be seen from the table that total travel produced by AIMSUN is higher

than that produced by VISSIM for most of the cases. There can be two reasons for this, one is an inconsistency in the input data between the models, and the other is inconsistent model behavior. The input data for the models falls into three categories: geometry, demand and control data. It has been ensured that the demands and control data coded into the models is identical while making sure that the differences in geometry are as minimal as possible. Therefore, such a result can only be explained as an inconsistent model behavior for similar constraints. It was observed from the animation of simulation that if vehicles do not get sufficient time to make lane changes while exiting the freeway they diffuse in VISSIM while they take the next available exit in AIMSUN. Moreover, it was observed that lane changing on links connected to entry nodes in VISSIM does not take place as expected especially if a short decision-making zone is involved. The total travel times between the models are comparable and most of the differences are within 10%. It can be observed that the estimated speeds on freeway mainline and ramps by the models are similar with most of the differences below 3% for these sections. However, the difference between estimated speeds on arterial sections is significant. Although some of this can be attributed to the fact that desired speeds for both the models are computed differently, it has to be noted that lane changing of VISSIM on arterial sections was not as expected resulting in lower speeds. The values of total delay as shown in the table are not comparable between the models. Both the models define delay as the difference between desired travel time and actual travel time. Although both models compute delay using the same definition, simulation of a simple case resulted in very different delay values. The reason for this is once again the different ways of computing desired speeds. Since the network under consideration is very large, it was difficult to find out as to where significant differences in delays between the models were occurring. As average delay is derived from total delay, a difference in this value, as estimated by the models is to be expected. It can also be observed that total number of stops and average number of stops are not comparable between the models. This can be attributed to different definitions and different parameters used by the models.

Table 17 shows the control delays at all the intersections in the study area. Although neither AIMSUN nor VISSIM provide control delay directly, the MOE was computed using the delays on different approaches of the intersection, which is provided

by both models. LOS of the intersections was computed using control delay as per the methodologies suggested in HCM, 2000. LOS obtained from the simulators was compared with the LOS as computed by SYNCHRO. The results shown in the table indicate that the LOS from the models is not comparable for most of the intersections. This is largely due to differences in estimated delay of the models. It can also be observed that the LOS from the simulators is not comparable with the LOS computed by SYNCHRO.

Apart from the results discussed above, we also looked at volume, speed, density, LOS and travel time on different links of the freeway sections. As pointed out earlier, these results are not presented here for conserving space. However, it is worth mentioning some important observations from these results:

- Volume, speed, density and travel times from both the models were comparable with differences which are insignificant on most of the links.
- As LOS for freeway sections is obtained from density, the LOS was also comparable for most of the cases.

Based on the above discussion, it can be seen that the results obtained from different models can be different for the same constraints. A decision on the adequacy of the design cannot be made unless the user decides which model is reliable.

Chapter 4 – Conclusions

The aim of this study was to estimate the adequacy of a new design using simulation. Two of the widely used microscopic simulators, AIMSUN and VISSIM were used for such purpose. Different MOEs were extracted from the output provided by these models. The results show that the differences between basic MOEs like volumes, speed, density and travel time are similar with both models. However, substantial differences between the two models were observed when it comes to estimating total delay and total number of stops. The discrepancies are mostly due to a difference in definition of some measures.

These results demonstrate the fact that some measures can be different with models for the same constraints. If only one model was applied the user is likely to accept the results unless graphic simulation displayed unusual results. Therefore before making a judgment on the adequacy of a design, one has to ensure the reliability and applicability of model to a particular scenario. Calibration of model parameters plays an important role in determining reliability of the model. A model that gives a reasonable accuracy and is able to simulate all the features of interest should be used while determining adequacy of a future design.

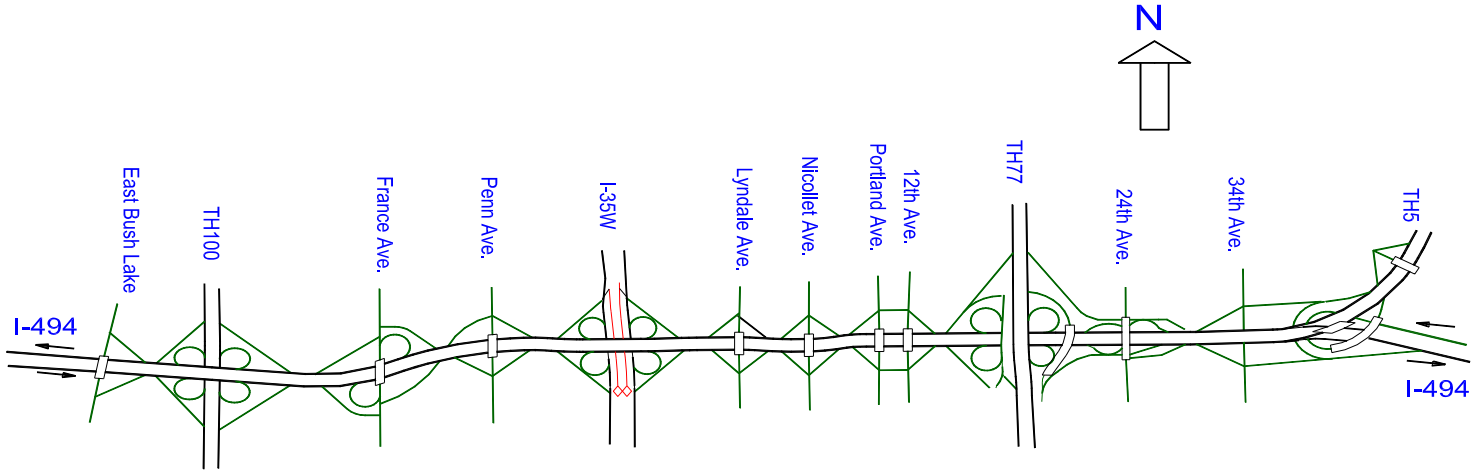
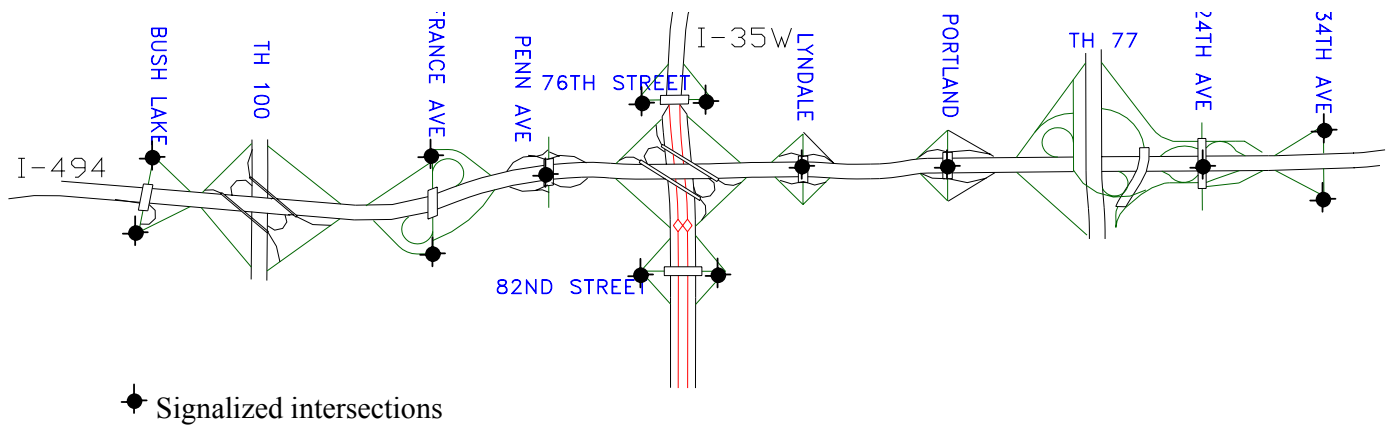
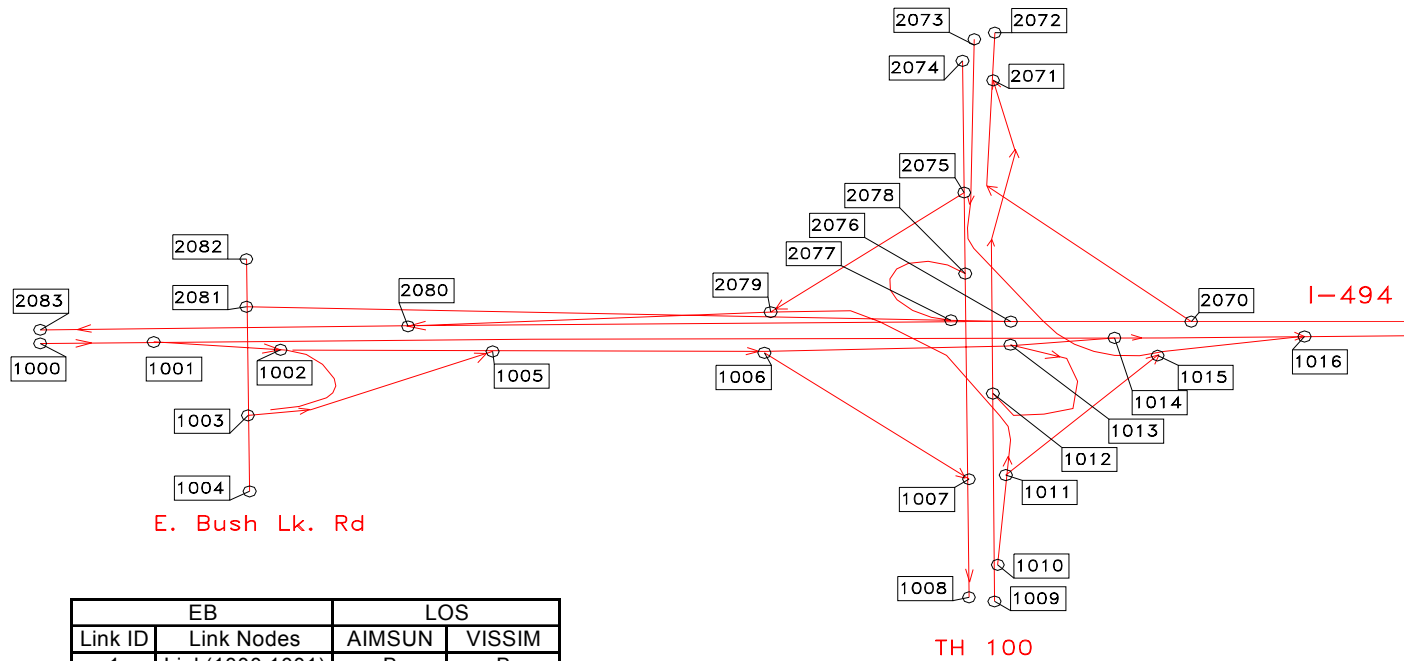

Figure 1a: Schematic for the Study Site (Existing Design)



◆ Signalized intersections

Figure 1b: Schematic for the Study Site (Future Design)



Link ID	EB Link Nodes	LOS	
		AIMSUN	VISSIM
1	Link(1000,1001)	B	B
2	Link(1001,1002)	C	C
3	Link(1002,1005)	B	B
4	Link(1002,1003)	A	B
5	Link(1003,1005)	B	B
6	Link(1005,1006)	A	A
7	Link(1006,1007)	A	A
8	Link(1006,1013)	B	A
9	Link(1013,1012)	A	A
10	Link(1013,1014)	C	B
11	Link(1001,1014)	B	A
12	Link(1014,1016)	B	B
13	Link(2073,1015)	D	E
14	Link(1011,1015)	B	F
15	Link(1015,1016)	D	D
16	Link(1016,1020)	B	B

Link ID	WB Link Nodes	LOS	
		AIMSUN	VISSIM
138	Link(2070,2076)	B	B
139	Link(2070,2071)	C	B
140	Link(2076,2077)	D	C
141	Link(2077,2078)	B	A
142	Link(2075,2079)	C	E
143	Link(1011,2079)	C	D
144	Link(2077,2081)	C	C
145	Link(2076,2080)	B	B
146	Link(2079,2080)	E	E
147	link(2080,2083)	C	B

Note: Highlighted rows indicate at least 2 orders in LOS difference.

Figure 2a Segment LOS Obtained from AIMSUN and VISSIM (EBL Road—TH100)

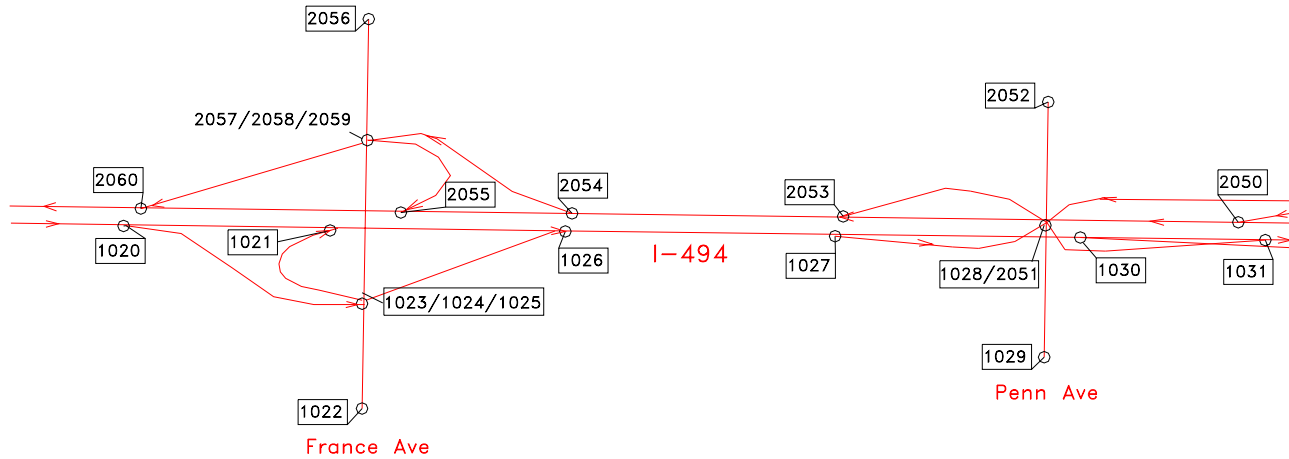

Link ID	EB Link Nodes	LOS	
		AIMSUN	VISSIM
17	Link(1020,1021)	B	B
18	Link(1020,1023)	A	B
19	Link(1024,1021)	C	B
20	Link(1021,1026)	C	C
21	Link(1025,1026)	B	C
22	Link(1026,1027)	C	C
23	Link(1027,1030)	D	C
24	Link(1027,1028)	A	A
25	Link(1028,1031)	C	C
26	Link(1030,1031)	B	B
27	Link(1030,1040)	C	E
28	Link(1031,1043)	B	B

Link ID	WB Link Nodes	LOS	
		AIMSUN	VISSIM
129	Link(2050,2053)	B	C
130	Link(2051,2053)	D	C
131	Link(2053,2054)	C	E
132	Link(2054,2055)	B	B
133	Link(2054,2057)	D	F
134	Link(2057,2055)	B	C
135	Link(2055,2060)	B	B
136	Link(2059,2060)	B	A
137	Link(2060,2070)	C	B

Note: Highlighted rows indicate at least 2 orders in LOS difference.

Figure 2b Segment LOS Obtained from AIMSUN and VISSIM (France Ave—Penn Ave)

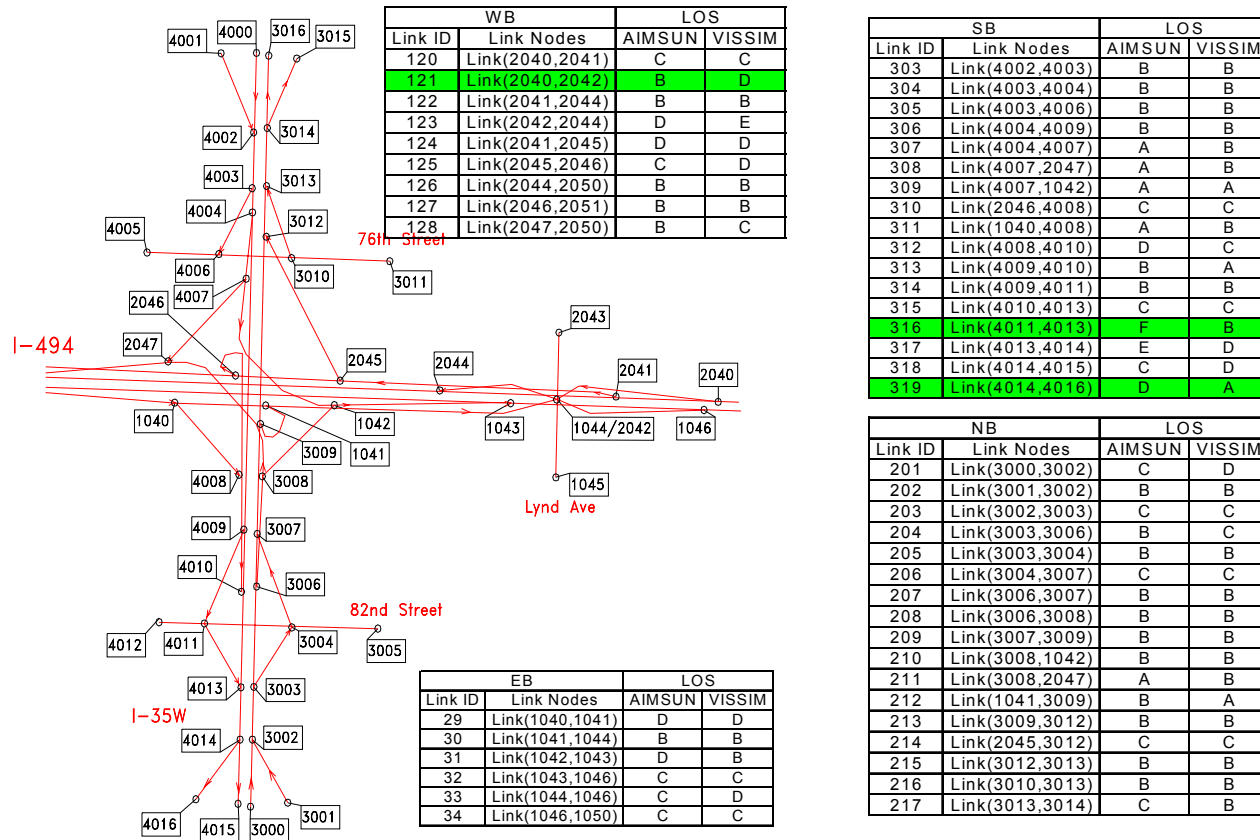

Note: Highlighted rows indicate at least 2 orders in LOS difference.

Figure 2c Segment LOS Obtained from AIMSUN and VISSIM (I-35W)

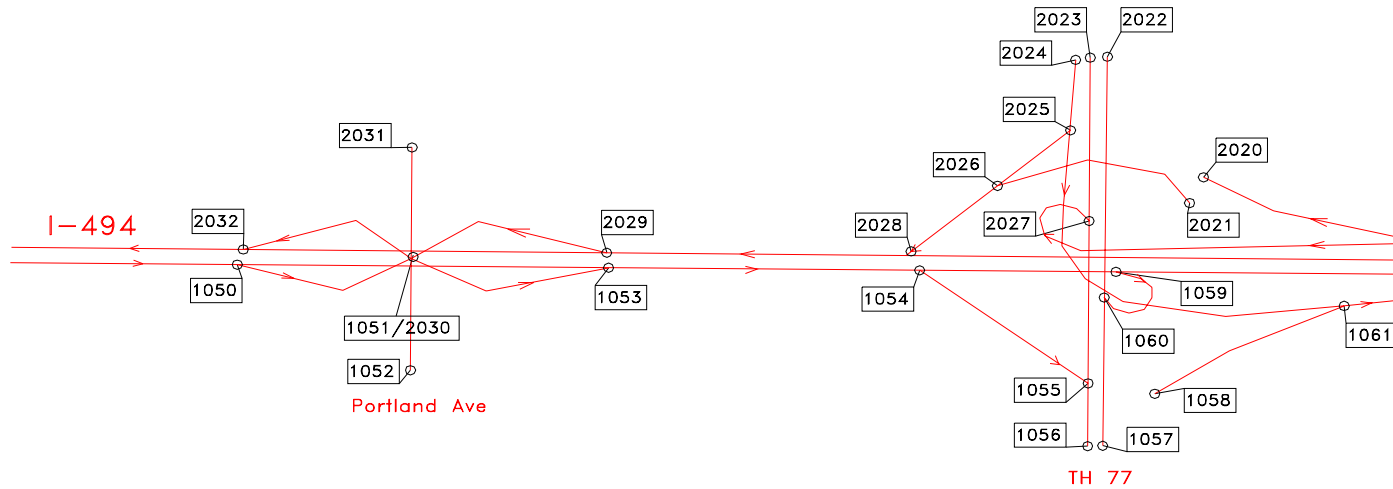

Link ID	EB		LOS	
	Link Nodes	AIMSUN	VISSIM	
35	Link(1050,1053)	D	C	
36	Link(1050,1051)	D	B	
37	Link(1051,1053)	F	C	
38	Link(1053,1054)	F	C	
39	Link(1054,1059)	C	B	
40	Link(1054,1055)	C	C	
41	Link(1059,1060)	B	B	
42	Link(1059,1070)	C	C	
43	Link(2025,1061)	A	A	
44	Link(1058,1061)	A	B	
45	Link(1061,1073)	B	C	

Link ID	WB		LOS	
	Link Nodes	AIMSUN	VISSIM	
112	Link(2021,2026)	D	C	
113	Link(2025,2026)	B	B	
114	Link(2026,2028)	F	E	
115	Link(2028,2029)	B	B	
116	Link(2029,2032)	C	C	
117	Link(2029,2030)	C	B	
118	Link(2030,2032)	C	C	
119	Link(2032,2040)	C	E	

Note: Highlighted rows indicate at least 2 orders in LOS difference.

Figure 2d Segment LOS Obtained from AIMSUN and VISSIM (Portland Ave—TH77)

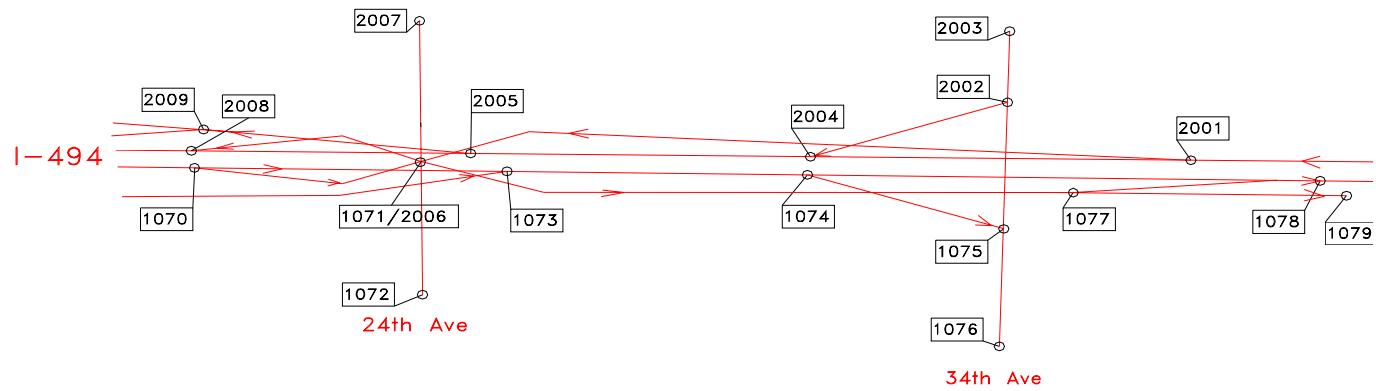

Link ID	EB	LOS	
	Link Nodes	AIMSUN	VISSIM
46	Link(1070,1073)	C	B
47	Link(1070,1071)	A	A
48	Link(1073,1074)	B	B
49	Link(1074,1078)	B	B
50	Link(1071,1077)	D	E
51	Link(1074,1075)	D	C

Link ID	W B	LOS	
	Link Nodes	AIMSUN	VISSIM
102	Link(2001,2004)	F	D
103	Link(2002,2004)	E	F
104	Link(2004,2005)	E	D
105	Link(2001,2006)	D	D
106	Link(2005,2008)	B	B
107	Link(2005,2009)	E	F
108	Link(2006,2008)	C	C
109	Link(2008,2028)	C	B
110	Link(2009,2027)	F	F
111	Link(2009,2020)	C	C

Note: Highlighted rows indicate at least 2 orders in LOS difference.

Figure 2e Segment LOS Obtained from AIMSUN and VISSIM (24th Ave—34th Ave)

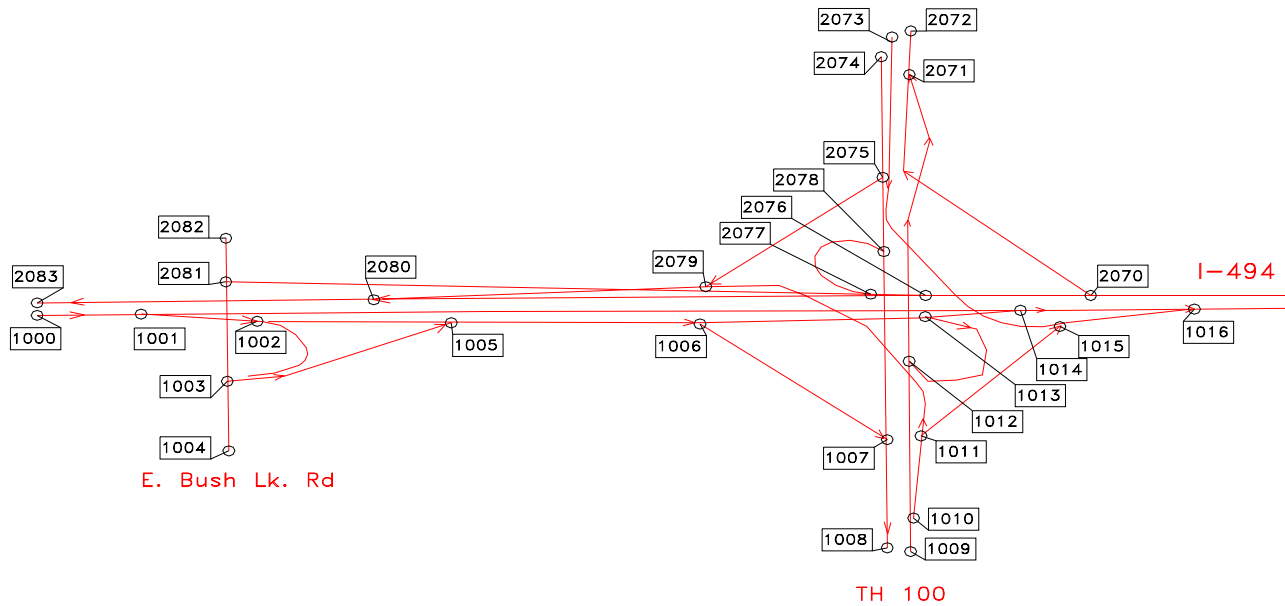

Intersection	Directions	Approaches	LOS	
			AIMSUN	VISSIM
East Bush Lake Rd. N	NB	T	A	B
East Bush Lake Rd. N	SB	T	B	C
East Bush Lake Rd. N	WB	L	B	A
East Bush Lake Rd. N	WB	R	A	A

Intersection	Directions	Approaches	LOS	
			AIMSUN	VISSIM
East Bush Lake Rd. S	NB	R	A	A
East Bush Lake Rd. S	NB	T	C	B
East Bush Lake Rd. S	SB	L	B	E
East Bush Lake Rd. S	SB	T	A	B
East Bush Lake Rd. S	WB	L	B	B
East Bush Lake Rd. S	WB	R	A	A

Note: Highlighted rows indicate at least 2 orders in LOS difference.

Figure 3a Intersection LOS Obtained from AIMSUN and VISSIM (EBL Road)

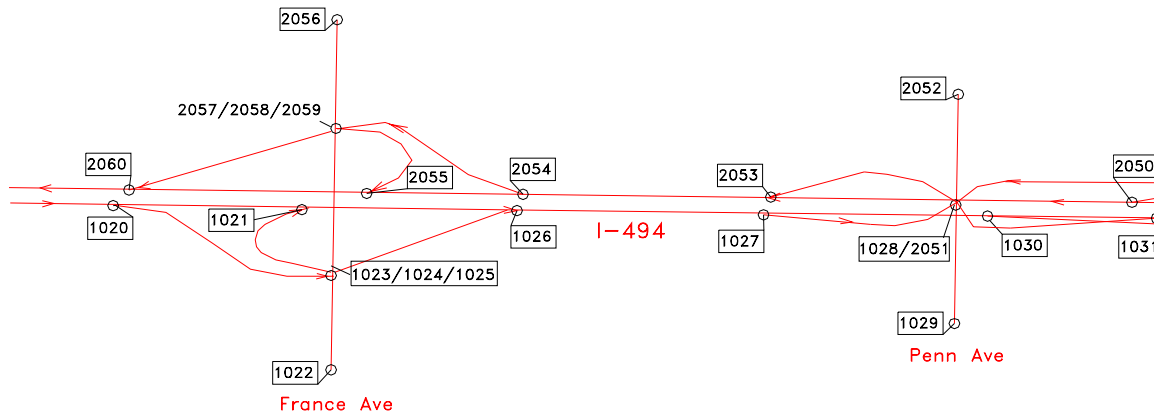

Intersection	Directions	Approaches	LOS	
			AIMSUN	VISSIM
France Ave N	EB	L	D	D
France Ave N	EB	R	A	C
France Ave N	NB	L	F	F
France Ave N	NB	R	F	D
France Ave N	NB	T	F	F
France Ave N	SB	R	C	A
France Ave N	SB	T	F	F
France Ave N	WB	L	D	C
France Ave N	WB	R	A	A
France Ave N	WB	T	D	C

Intersection	Directions	Approaches	LOS	
			AIMSUN	VISSIM
Penn Ave.	EB	L	B	A
Penn Ave.	EB	R	A	C
Penn Ave.	NB	L	F	C
Penn Ave.	NB	R	A	A
Penn Ave.	NB	T	B	B
Penn Ave.	SB	L	C	C
Penn Ave.	SB	R	A	A
Penn Ave.	SB	T	B	B
Penn Ave.	WB	L	C	C
Penn Ave.	WB	R	A	A

Intersection	Directions	Approaches	LOS	
			AIMSUN	VISSIM
France Ave S	EB	L	E	A
France Ave S	EB	R	A	A
France Ave S	NB	R	D	A
France Ave S	NB	T	E	D
France Ave S	SB	R	A	A

Note: Highlighted rows indicate at least 2 orders in LOS difference.

Figure 3b Intersection LOS Obtained from AIMSUN and VISSIM (France Ave, Penn Ave)

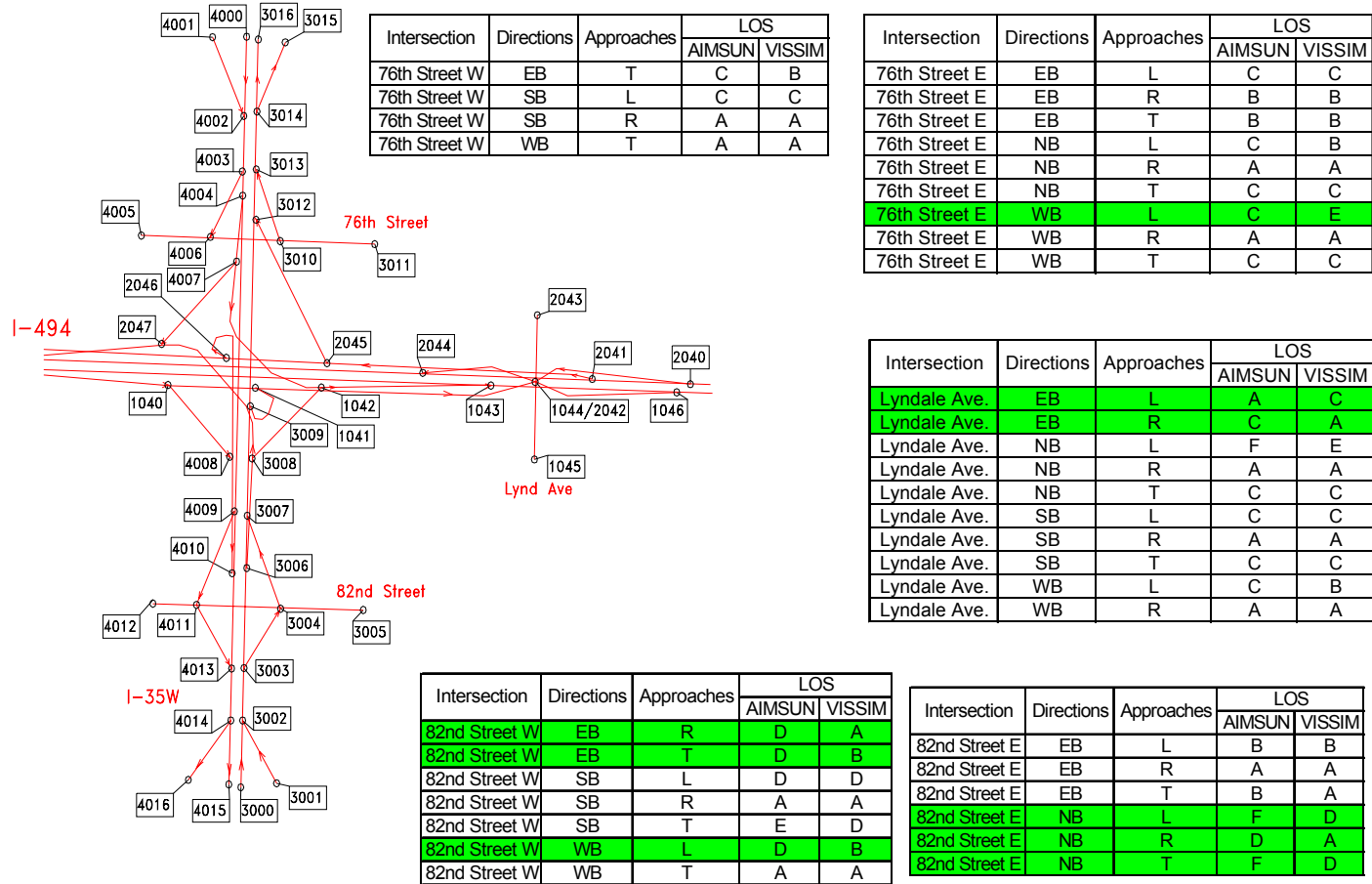

Note: Highlighted rows indicate at least 2 orders in LOS difference.

Figure 3c Intersection LOS Obtained from AIMSUN and VISSIM (Lynd Ave, 76th Str. and 82nd Str.)

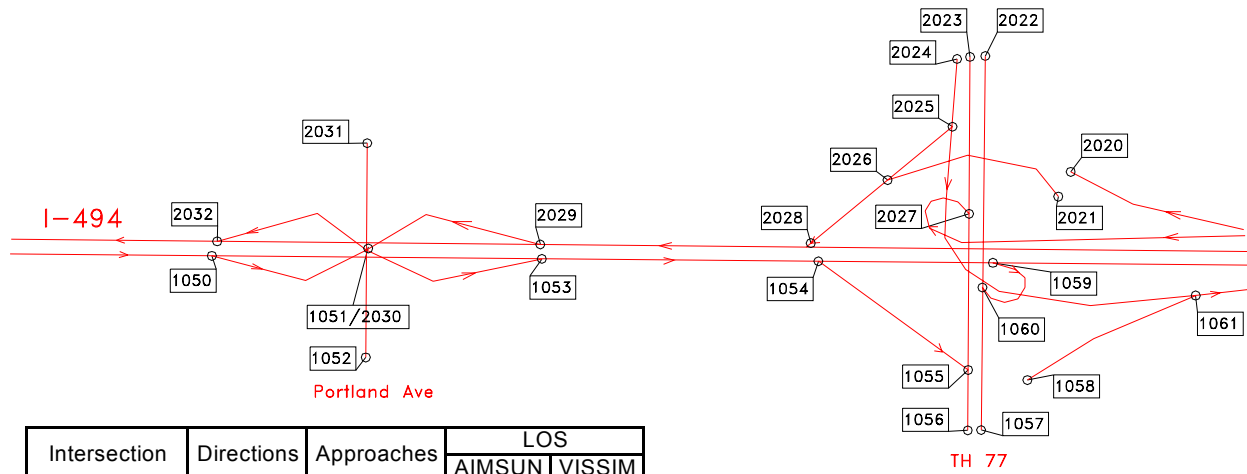

Intersection	Directions	Approaches	LOS	
			AIMSUN	VISSIM
Portland Ave.	EB	L	F	D
Portland Ave.	EB	R	A	A
Portland Ave.	NB	L	C	C
Portland Ave.	NB	R	A	A
Portland Ave.	NB	T	B	B
Portland Ave.	SB	L	E	C
Portland Ave.	SB	R	A	A
Portland Ave.	SB	T	B	B
Portland Ave.	WB	L	E	D
Portland Ave.	WB	R	A	A

Note: Highlighted rows indicate at least 2 orders in LOS difference.

Figure 3d Intersection LOS Obtained from AIMSUN and VISSIM (Portland Ave)

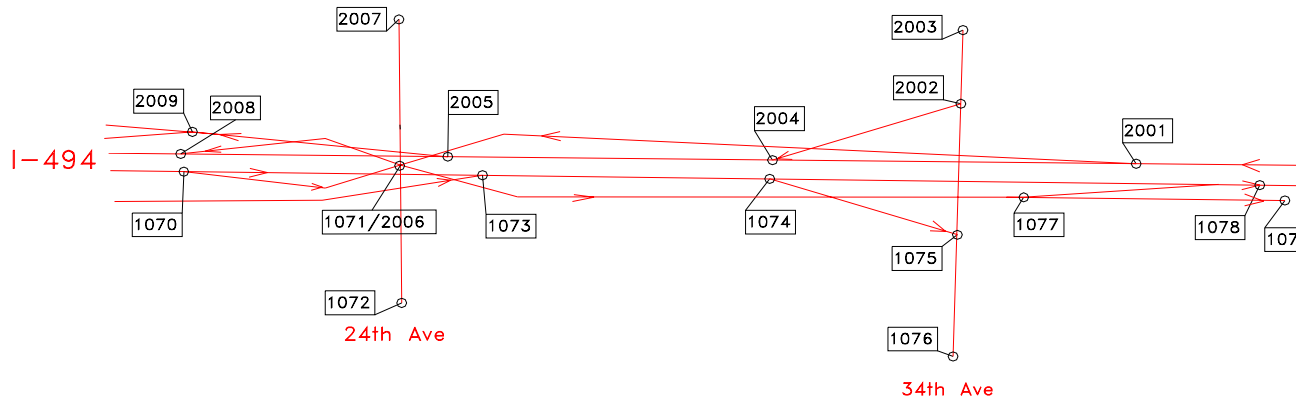

Intersection	Directions	Approaches	LOS	
			AIMSUN	VISSIM
24th Ave.	EB	L	B	B
24th Ave.	EB	R	A	A
24th Ave.	NB	L	D	E
24th Ave.	NB	R	A	D
24th Ave.	NB	T	D	E
24th Ave.	SB	L	D	D
24th Ave.	SB	R	A	A
24th Ave.	SB	T	D	D
24th Ave.	WB	L	C	C
24th Ave.	WB	R	A	A

Intersection	Directions	Approaches	LOS	
			AIMSUN	VISSIM
34th Ave. N	NB	L	F	C
34th Ave. N	NB	T	C	A
34th Ave. N	SB	R	A	D
34th Ave. N	SB	T	E	C
34th Ave. N	WB	L	F	D
34th Ave. N	WB	R	D	A
34th Ave. N	WB	T	D	A

Intersection	Directions	Approaches	LOS	
			AIMSUN	VISSIM
34th Ave. S	EB	L	E	C
34th Ave. S	EB	R	A	A
34th Ave. S	EB	T	B	A
34th Ave. S	NB	R	F	D
34th Ave. S	NB	T	F	F
34th Ave. S	SB	L	F	C
34th Ave. S	SB	T	B	A

Note: Highlighted rows indicate at least 2 orders in LOS difference.

Figure 3e Intersection LOS Obtained from AIMSUN and VISSIM (24th Ave, 34th Ave)

Table 1 Hourly MOEs and LOS for the Segments of WB I-494 (AIMSUN)

				3:00 to 4:00 PM				
along		Location	Link	Volume (vph)	Speed (mph)	Density (vpmpl)	LOS	Travel Time (sec-veh)
EB I-494	EB 1	Upstream I-494 EB	Link(1000,1001)	4869	70	18	B	60
	EB 2	Exit to EBL & TH100	Link(1001,1002)	1028	35	27	D	12
	EB 3	To TH100	Link(1002,1005)	504	34	15	B	21
	EB 4	To EBL	Link(1002,1003)	403	34	12	B	11
	EB 5	From EBL	Link(1003,1005)	600	41	11	B	32
	EB 6	To TH100 & I-494 Commons	Link(1005,1006)	1103	52	10	A	13
	EB 7	To TH100 SB	Link(1006,1007)	261	34	8	A	24
	EB 8	To TH100 NB & I-494	Link(1006,1013)	842	34	12	B	19
	EB 9	To TH100 NB	Link(1013,1012)	200	37	4	A	12
	EB 10	To I-494	Link(1013,1014)	640	34	20	C	9
	EB 11	I-494 EB	Link(1001,1014)	3844	56	18	C	46
	EB 12	I-494 EB	Link(1014,1016)	4483	67	18	B	13
	EB 13	From TH100 NB	Link(2073,1015)	2118	34	31	D	43
	EB 14	From TH100 SB	Link(1011,1015)	610	34	18	B	22
	EB 15	Entrance from TH100	Link(1015,1016)	2723	51	27	D	8
	EB 16	I-494 EB	Link(1016,1020)	7204	69	17	B	19
	EB 17	I-494 EB	Link(1020,1021)	6354	72	15	B	8
	EB 18	Exit to France Ave	Link(1020,1023)	849	50	13	B	15
	EB 19	Entrance from France Ave SB	Link(1024,1021)	948	34	22	C	37
	EB 20	I-494 EB	Link(1021,1026)	7296	66	20	C	15
	EB 21	Entrance from France Ave NB	Link(1025,1026)	536	41	12	B	29
	EB 22	I-494 EB	Link(1026,1027)	7836	59	26	D	31
	EB 23	I-494 EB	Link(1027,1030)	7337	51	35	D	17
	EB 24	Exit to Penn Ave	Link(1027,1028)	474	51	8	A	18
	EB 25	Entrance from Penn Ave	Link(1028,1031)	1070	41	18	B	48
	EB 26	I-494 EB	Link(1030,1031)	4111	72	14	B	23
	EB 27	Exit To I-35W	Link(1030,1040)	3222	64	25	C	18
	EB 28	I-494	Link(1031,1043)	5180	70	18	C	37
	EB 29	To I-35W & Lynd Ave	Link(1040,1041)	1577	65	24	C	13
	EB 30	To Lynd Ave	Link(1041,1044)	738	52	12	B	24
	EB 31	Entrance from I-35W	Link(1042,1043)	1459	40	36	E	56
	EB 32	I-494 EB	Link(1043,1046)	6802	69	20	C	8
	EB 33	Entrance Ave Lynd Ave	Link(1044,1046)	1000	42	19	C	48
	EB 34	I-494 EB	Link(1046,1050)	7807	69	19	C	18
	EB 35	I-494 EB	Link(1050,1053)	6692	65	27	D	44
	EB 36	Exit to Portland Ave	Link(1050,1051)	1099	47	39	E	100
	EB 37	Entrance from Portland Ave	Link(1051,1053)	898	34	39	E	81
	EB 38	I-494 EB	Link(1053,1054)	7504	48	48	F	50
	EB 39	I-494 EB	Link(1054,1059)	6065	63	22	C	19
	EB 40	Exit to TH77 SB	Link(1054,1055)	1428	35	21	C	15
	EB 41	Exit to TH77 NB	Link(1059,1060)	487	35	14	B	9
	EB 42	I-494 EB	Link(1059,1070)	5568	63	20	C	8
	EB 43	From TH77 SB	Link(2025,1061)	336	35	10	A	38
	EB 44	From TH77 NB	Link(1058,1061)	472	35	15	B	14
	EB 45	Entrance From TH77	Link(1061,1073)	813	34	25	C	34
	EB 46	I-494 EB	Link(1070,1073)	4990	70	18	C	21
	EB 47	Exit to 24th Ave	Link(1070,1071)	569	35	12	B	23
	EB 48	I-494 EB	Link(1073,1074)	5792	66	18	C	21
	EB 49	I-494 EB	Link(1074,1078)	4161	73	15	B	13
	EB 50	From 24th Ave	Link(1071,1077)	976	34	24	C	61
	EB 51	Exit to 34th Ave	Link(1074,1075)	1633	38	32	D	13

Table 2 Hourly MOEs and LOS for the Segments of WB I-494 (AIMSUN)

				3:00 to 4:00 PM				
		Location	Link	Volume	Speed	Density	LOS	Travel Time
along				(vph)	(mph)	(vpmpl)		(sec-veh)
WB I-494	WB 101	Upstream I-494 WB	Link(2000,2001)					
	WB 102	I-494 WB	Link(2001,2004)	5157	54	33	D	24
	WB 103	Entrance from 34th Ave	Link(2002,2004)	1417	28	43	E	30
	WB 104	I-494 WB	Link(2004,2005)	6553	59	23	C	21
	WB 105	Exit to 24th Ave	Link(2001,2006)	1318	34	30	D	80
	WB 106	I-494 WB	Link(2005,2008)	4394	59	19	C	27
	WB 107	Exit to TH77	Link(2005,2008)	2156	34	32	D	46
	WB 108	Entrance from 24th Ave	Link(2006,2008)	972	34	24	C	44
	WB 109	I-494 WB	Link(2008,2028)	5348	57	24	C	30
	WB 110	TO TH77 SB	Link(2009,2027)	1392	33	43	E	26
	WB 111	TO TH77 NB	Link(2009,2020)	755	34	23	C	11
	WB 112	From TH77 NB	Link(2021,2026)	1464	33	28	D	27
	WB 113	From TH77 SB	Link(2025,2026)	421	34	13	B	23
	WB 114	Entrance from TH77	Link(2026,2028)	1850	30	81	F	29
	WB 115	I-494 WB	Link(2028,2029)	7190	67	18	C	24
	WB 116	I-494 WB	Link(2029,2032)	6328	68	19	C	29
	WB 117	Exit to Portland Ave	Link(2029,2030)	860	34	21	C	26
	WB 118	Entrance from Portland Ave	Link(2030,2032)	1026	44	21	C	43
	WB 119	I-494 WB	Link(2032,2040)	7342	58	24	C	10
	WB 120	I-494 WB	Link(2040,2041)	6627	63	22	C	21
	WB 121	Exit to Lynd Ave	Link(2040,2042)	718	51	11	B	34
	WB 122	I-494 WB	Link(2041,2044)	4099	72	15	B	23
	WB 123	Entrance from Lynd Ave	Link(2042,2044)	986	28	38	E	66
	WB 124	Exit to I35W & Penn Ave	Link(2041,2045)	2523	34	36	E	40
	WB 125	To I35W SB & Penn Ave	Link(2045,2046)	1777	34	25	C	24
	WB 126	I-494 WB	Link(2044,2050)	5067	70	18	C	37
	WB 127	To Penn Ave	Link(2046,2051)	954	35	14	B	37
	WB 128	From I35W	Link(2047,2050)	2084	69	14	B	19
	WB 129	I-494 WB	Link(2050,2053)	7149	71	17	B	11
	WB 130	Entrance from Penn Ave	Link(2051,2053)	502	30	21	C	236
	WB 131	I-494 WB	Link(2053,2054)	7654	62	21	C	25
	WB 132	I-494 WB	Link(2054,2055)	6262	65	16	B	12
	WB 133	Exit to France Ave	Link(2054,2057)	1066	34	21	C	17
	WB 134	Entrance from France Ave SB	Link(2055,2055)	570	34	9	A	10
	WB 135	I-494 WB	Link(2055,2060)	6828	68	18	B	10
	WB 136	Entrance from France Ave NB	Link(2059,2060)	585	41	14	B	71
	WB 137	I-494 WB	Link(2060,2070)	7413	60	22	C	23
	WB 138	I-494 WB	Link(2070,2076)	5750	67	18	B	13
	WB 139	Exit to TH100	Link(2070,2071)	956	34	19	C	64
	WB 140	To TH100 & EBL	Link(2076,2077)	1082	35	29	D	6
	WB 141	To TH100	Link(2077,2078)	393	34	12	B	12
	WB 142	From TH100 SB	Link(2075,2079)	749	34	22	C	40
	WB 143	From TH100 NB	Link(1011,2079)	586	35	17	B	37
	WB 144	To EBL	Link(2077,2081)	690	34	20	C	43
	WB 145	I-494 WB	Link(2077,2080)	3958	71	17	B	25
	WB 146	Entrance From TH100	Link(2079,2080)	1333	33	40	E	9
	WB 147	I-494 WB Downstream	link(2080,2083)	5994	59	20	C	18

Table 3 Hourly MOEs and LOS for the Segments of NB I-35W (AIMSUN)

			3:00 to 4:00 PM					
along		Location	Link	Volume	Speed	Density	LOS	Travel Time
				(vph)	(mph)	(vpmpl)		(sec-veh)
NB I-35W	NB 201	Upstream I-35W NB	Link(3000,3002)	4749	71	23	C	9
	NB 202	Entrance from 90th Street	Link(3001,3002)	505	35	15	B	12
	NB 203	I-35W NB	Link(3002,3003)	5252	66	20	C	16
	NB 204	I-35W NB	Link(3003,3006)	4815	65	18	C	23
	NB 205	Exit to 82nd Street	Link(3003,3004)	434	35	12	B	46
	NB 206	Entrance from 82nd Street	Link(3004,3007)	493	32	17	B	71
	NB 207	I-35W NB	Link(3006,3007)	2395	73	11	B	16
	NB 208	Exit to I-494	Link(3006,3008)	2419	69	18	B	14
	NB 209	I-35W NB	Link(3007,3009)	3135	68	16	B	11
	NB 210	To I-494 EB	Link(3008,1042)	964	55	17	B	4
	NB 211	To I-494 WB	Link(3008,2047)	1456	72	10	A	8
	NB 212	From I-494 EB	Link(1047,3009)	836	55	15	B	12
	NB 213	I-35W NB	Link(3009,3012)	3969	70	14	B	12
	NB 214	From I-494 WB	Link(2045,3012)	742	34	22	C	44
	NB 215	I-35W NB	Link(3012,3013)	4703	69	18	B	13
	NB 216	Entrance from 76th Street	Link(3010,3013)	537	33	11	A	68
	NB 217	I-35W NB	Link(3013,3014)	5231	66	19	C	11
	NB 218	I-35W NB	Link(3014,3016)					
	NB 219	Exit to 66th Street	Link(3014,3015)					

Table 4 Hourly MOEs and LOS for the Segments of NB I-35W (AIMSUN)

				3:00 to 4:00 PM				
along		Location	Link	Volume (vph)	Speed (mph)	Density (vpmp)	LOS	Travel Time (sec-veh)
SB I-35W	SB 301	Upstream I-35W SB	Link(4000,4002)					
	SB 302	Entrance from 66th Street	Link(4001,4002)					
	SB 303	I-35W SB	Link(4002,4003)	4721	72	13	B	10
	SB 304	I-35W SB	Link(4003,4004)	4339	71	12	B	13
	SB 305	Exit to 76th Street	Link(4003,4006)	381	35	11	A	42
	SB 306	I-35W SB	Link(4004,4009)	3058	72	14	B	23
	SB 307	Exit to I-494	Link(4004,4007)	1281	71	9	A	13
	SB 308	To I-494 WB	Link(4007,2047)	629	72	9	A	0
	SB 309	To I-494 EB	Link(4007,1042)	653	71	9	A	4
	SB 310	From I-494 WB	Link(2046,4009)	824	34	25	C	25
	SB 311	From I-494 EB	Link(1040,4008)	1645	71	12	B	1
	SB 312	Entrance from I-494	Link(4008,4010)	2474	34	36	E	44
	SB 313	I-35W SB	Link(4009,4010)	2496	73	12	B	22
	SB 314	Exit to 82nd Ave	Link(4009,4011)	558	35	14	B	26
	SB 315	I-35W SB	Link(4010,4013)	4975	62	20	C	22
	SB 316	Entrance from 82nd Ave	Link(4011,4013)	556	33	14	B	81
	SB 317	I-35W SB	Link(4013,4014)	5533	42	34	D	25
	SB 318	I-35W SB	Link(4014,4015)	5006	70	24	C	9
	SB 319	Exit to 90th Street	Link(4014,4016)	526	35	15	B	5

Table 5 Hourly MOEs and LOS for the arterial sections of EBL Road (AIMSUN)

			3:00 to 4:00 PM				
			Volume	Speed	Density	LOS	Travel Time
Direction			(vph)	(mph)	(vpmpl)		(sec-veh)
North Ramp	Entry Node	EBL North Ramp	834	28	26		25
	EBL North Ramp	EBL South Ramp	1239	28	19		21
	EBL South Ramp	Exit Node	1144	34	17		10
South Ramp	Entry Node	EBL South Ramp	432	27	7		23
	EBL South Ramp	EBL North Ramp	448	26	11		22
	EBL North Ramp	Exit Node	730	32	12		14

Table 6 Hourly MOEs and LOS for Intersection Approaches (24th Ave, AIMSUN)

			3:00 to 4:00 PM		
Intersection	Directions	Approaches	Volume	Delay	LOS
24th Ave.	EB	L	239	19	B
24th Ave.	EB	R	328	0	A
24th Ave.	NB	L	680	41	D
24th Ave.	NB	R	1326	0	A
24th Ave.	NB	T	360	37	D
24th Ave.	SB	L	228	37	D
24th Ave.	SB	R	293	0	A
24th Ave.	SB	T	205	37	D
24th Ave.	WB	L	1141	24	C
24th Ave.	WB	R	205	2	A

Table 7 Hourly Overall MOEs and LOS for Signalized Intersections (AIMSUN)

Intersection	Stop control	3:00 to 4:00 PM		3:15 to 4:15 PM	
		Control delay	LOS	Control delay	LOS
		(sec/veh)		(sec/veh)	
24th Ave.	Signal Control	18	B	18	B
34th Ave. N	Signal Control	38	D	35	D
34th Ave. S	Signal Control	37	D	38	D
76th Street E	Signal Control	17	B	17	B
76th Street W	Signal Control	17	B	17	B
82nd Street E	Signal Control	19	B	19	B
82nd Street W	Signal Control	12	B	12	B
East Bush Lake Rd. N	Signal Control	11	B	12	B
East Bush Lake Rd. S	Signal Control	11	B	11	B
France Ave N	Signal Control	90	F	107	F
France Ave S	Signal Control	20	B	31	C
Lyndale Ave.	Signal Control	33	C	31	C
Penn Ave.	Signal Control	12	B	13	B
Portland Ave.	Signal Control	33	C	33	C

Table 8 Hourly MOEs and LOS for the Segments of WB I-494 (VISSIM)

along		Location	Link	3:00 to 4:00 PM				
				Volume (vph)	Speed (mph)	Density (vpmpl)	LOS	Travel Time (sec-veh)
EB I-494	EB 1	Upstream I-494 EB	Link(1000,1001)	4806	73	16	B	60
	EB 2	Exit to EBL & TH100	Link(1001,1002)	995	44	24	C	16
	EB 3	To TH100	Link(1002,1005)	481	33	15	B	24
	EB 4	To EBL	Link(1002,1003)	510	29	14	B	15
	EB 5	From EBL	Link(1003,1005)	530	28	12	B	33
	EB 6	To TH100 & I-494 Commons	Link(1005,1006)	1012	58	9	A	11
	EB 7	To TH100 SB	Link(1006,1007)	221	38	6	A	25
	EB 8	To TH100 NB & I-494	Link(1006,1013)	789	61	7	A	11
	EB 9	To TH100 NB	Link(1013,1012)	188	61	3	A	12
	EB 10	To I-494	Link(1013,1014)	598	60	10	A	7
	EB 11	I-494 EB	Link(1001,1014)	4086	71	14	B	44
	EB 12	I-494 EB	Link(1014,1016)	4391	72	14	B	13
	EB 13	From TH100 NB	Link(2073,1015)	2105	27	39	E	51
	EB 14	From TH100 SB	Link(1011,1015)	536	9	104	F	139
	EB 15	Entrance from TH100	Link(1015,1016)	2639	48	28	D	18
	EB 16	I-494 EB	Link(1016,1020)	7033	68	17	B	23
	EB 17	I-494 EB	Link(1020,1021)	6183	66	16	B	12
	EB 18	Exit to France Ave	Link(1020,1023)	856	34	19	C	25
	EB 19	Entrance from France Ave SB	Link(1024,1021)	497	23	15	B	32
	EB 20	I-494 EB	Link(1021,1026)	6683	64	19	C	17
	EB 21	Entrance from France Ave NB	Link(1025,1026)	550	27	16	B	42
	EB 22	I-494 EB	Link(1026,1027)	7223	60	23	C	25
	EB 23	I-494 EB	Link(1027,1030)	6766	64	23	C	13
	EB 24	Exit to Penn Ave	Link(1027,1028)	445	65	6	A	7
	EB 25	Entrance from Penn Ave	Link(1028,1031)	1054	27	25	C	48
	EB 26	I-494 EB	Link(1030,1031)	3764	68	15	B	28
	EB 27	Exit To I-35W	Link(1030,1040)	2982	50	33	D	27
	EB 28	I-494	Link(1031,1043)	4803	67	17	B	42
	EB 29	To I-35W & Lynd Ave	Link(1040,1041)	1450	54	25	C	20
	EB 30	To Lynd Ave	Link(1041,1044)	708	61	11	A	25
	EB 31	Entrance from I-35W	Link(1042,1043)	1572	70	17	B	26
	EB 32	I-494 EB	Link(1043,1046)	6375	67	19	C	11
	EB 33	Entrance Ave Lynd Ave	Link(1044,1046)	997	26	23	C	48
	EB 34	I-494 EB	Link(1046,1050)	7375	64	20	C	18
	EB 35	I-494 EB	Link(1050,1053)	6302	68	18	C	34
	EB 36	Exit to Portland Ave	Link(1050,1051)	1051	43	18	B	19
	EB 37	Entrance from Portland Ave	Link(1051,1053)	878	28	19	C	43
	EB 38	I-494 EB	Link(1053,1054)	7143	61	22	C	21
	EB 39	I-494 EB	Link(1054,1059)	5726	65	18	B	16
	EB 40	Exit to TH77 SB	Link(1054,1055)	1421	41	20	C	21
	EB 41	Exit to TH77 NB	Link(1059,1060)	457	47	10	A	15
	EB 42	I-494 EB	Link(1059,1070)	5260	66	20	C	7
	EB 43	From TH77 SB	Link(2025,1061)	340	32	11	B	76
	EB 44	From TH77 NB	Link(1058,1061)	472	30	16	B	36
	EB 45	Entrance From TH77	Link(1061,1073)	817	33	26	C	30
	EB 46	I-494 EB	Link(1070,1073)	4717	70	17	B	27
	EB 47	Exit to 24th Ave	Link(1070,1071)	543	42	10	A	25
	EB 48	I-494 EB	Link(1073,1074)	5534	67	17	B	20
	EB 49	I-494 EB	Link(1074,1078)	4552	71	16	B	17
	EB 50	From 24th Ave	Link(1071,1077)	1543	31	34	D	52
	EB 51	Exit to 34th Ave	Link(1074,1075)	979	38	22	C	15

Table 9 Hourly MOEs and LOS for the Segments of WB I-494 (VISSIM)

along			Location	Link	3:00 to 4:00 PM				
					Volume (vph)	Speed (mph)	Density (vpmp)	LOS	Travel Time (sec-veh)
WB I-494	WB 101		Upstream I-494 WB	Link(2000,2001)					
	WB 102		I-494 WB	Link(2001,2004)	5134	69	22	C	17
	WB 103		Entrance from 34th Ave	Link(2002,2004)	1406	13	87	F	40
	WB 104		I-494 WB	Link(2004,2005)	6539	52	29	D	21
	WB 105		Exit to 24th Ave	Link(2001,2006)	1376	34	35	E	82
	WB 106		I-494 WB	Link(2005,2008)	4380	68	17	B	29
	WB 107		Exit to TH77	Link(2005,2008)	2151	34	69	F	52
	WB 108		Entrance from 24th Ave	Link(2006,2008)	976	20	26	C	46
	WB 109		I-494 WB	Link(2008,2028)	5313	70	18	C	23
	WB 110		TO TH77 SB	Link(2009,2027)	1386	31	45	F	51
	WB 111		TO TH77 NB	Link(2009,2020)	761	31	24	C	19
	WB 112		From TH77 NB	Link(2021,2026)	1464	31	24	C	30
	WB 113		From TH77 SB	Link(2025,2026)	423	25	15	B	26
	WB 114		Entrance from TH77	Link(2026,2028)	1891	21	48	F	28
	WB 115		I-494 WB	Link(2028,2029)	7202	69	19	C	23
	WB 116		I-494 WB	Link(2029,2032)	6366	66	20	C	35
	WB 117		Exit to Portland Ave	Link(2029,2030)	825	37	17	B	25
	WB 118		Entrance from Portland Ave	Link(2030,2032)	984	23	23	C	47
	WB 119		I-494 WB	Link(2032,2040)	7364	34	42	E	17
	WB 120		I-494 WB	Link(2040,2041)	6512	53	25	C	12
	WB 121		Exit to Lynd Ave	Link(2040,2042)	846	32	27	D	40
	WB 122		I-494 WB	Link(2041,2044)	4027	73	15	B	33
	WB 123		Entrance from Lynd Ave	Link(2042,2044)	767	10	54	F	110
	WB 124		Exit to I35W & Penn Ave	Link(2041,2045)	2479	34	37	E	66
	WB 125		To I35W SB & Penn Ave	Link(2045,2046)	1738	31	29	D	26
	WB 126		I-494 WB	Link(2044,2050)	4803	74	16	B	41
	WB 127		To Penn Ave	Link(2046,2051)	921	31	16	B	47
	WB 128		From I35W	Link(2047,2050)	2071	74	12	B	23
	WB 129		I-494 WB	Link(2050,2053)	6868	75	15	B	11
	WB 130		Entrance from Penn Ave	Link(2051,2053)	521	24	12	B	49
	WB 131		I-494 WB	Link(2053,2054)	7375	66	18	C	21
	WB 132		I-494 WB	Link(2054,2055)	6034	69	15	B	14
	WB 133		Exit to France Ave	Link(2054,2057)	1283	16	42	E	56
	WB 134		Entrance from France Ave SB	Link(2055,2055)	459	20	18	C	40
	WB 135		I-494 WB	Link(2055,2060)	6481	72	15	B	16
	WB 136		Entrance from France Ave NB	Link(2059,2060)	277	30	7	A	40
	WB 137		I-494 WB	Link(2060,2070)	6755	72	16	B	19
	WB 138		I-494 WB	Link(2070,2076)	5256	64	17	B	13
	WB 139		Exit to TH100	Link(2070,2071)	734	37	14	B	54
	WB 140		To TH100 & EBL	Link(2076,2077)	934	43	22	C	7
	WB 141		To TH100	Link(2077,2078)	339	33	11	A	27
	WB 142		From TH100 SB	Link(2075,2079)	741	21	37	E	60
	WB 143		From TH100 NB	Link(1011,2079)	585	26	23	C	62
	WB 144		To EBL	Link(2077,2081)	597	31	17	B	74
	WB 145		I-494 WB	Link(2077,2080)	4323	72	15	B	29
	WB 146		Entrance From TH100	Link(2079,2080)	1325	39	36	E	14
	WB 147		I-494 WB Downstream	link(2080,2083)	5648	73	16	B	17

Table 10 Hourly MOEs and LOS for the Segments of NB I-35W (VISSIM)

				3:00 to 4:00 PM				
along		Location	Link	Volume (vph)	Speed (mph)	Density (vpmpl)	LOS	Travel Time (sec-veh)
NB I-35W	NB 201	Upstream I-35W NB	Link(3000,3002)	4732	54	30	D	19
	NB 202	Entrance from 90th Street	Link(3001,3002)	502	34	16	B	15
	NB 203	I-35W NB	Link(3002,3003)	5229	69	19	C	14
	NB 204	I-35W NB	Link(3003,3006)	4796	71	19	C	20
	NB 205	Exit to 82nd Street	Link(3003,3004)	430	34	11	A	57
	NB 206	Entrance from 82nd Street	Link(3004,3007)	651	28	17	B	44
	NB 207	I-35W NB	Link(3006,3007)	2411	73	11	B	28
	NB 208	Exit to I-494	Link(3006,3008)	2379	70	17	B	22
	NB 209	I-35W NB	Link(3007,3009)	3041	68	15	B	13
	NB 210	To I-494 EB	Link(3008,1042)	918	71	13	B	14
	NB 211	To I-494 WB	Link(3008,2047)	1452	74	10	A	19
	NB 212	From I-494 EB	Link(1047,3009)	738	65	12	B	23
	NB 213	I-35W NB	Link(3009,3012)	3774	73	14	B	14
	NB 214	From I-494 WB	Link(2045,3012)	735	28	27	D	70
	NB 215	I-35W NB	Link(3012,3013)	4489	70	15	B	14
	NB 216	Entrance from 76th Street	Link(3010,3013)	520	28	15	B	56
	NB 217	I-35W NB	Link(3013,3014)	5011	67	17	B	11
	NB 218	I-35W NB	Link(3014,3016)					
	NB 219	Exit to 66th Street	Link(3014,3015)					

Table 11 Hourly MOEs and LOS for the Segments of SB I-35W (VISSIM)

				3:00 to 4:00 PM				
along		Location	Link	Volume (vph)	Speed (mph)	Density (vpmpl)	LOS	Travel Time (sec-veh)
SB I-35W	SB 301	Upstream I-35W SB	Link(4000,4002)					
	SB 302	Entrance from 66th Street	Link(4001,4002)					
	SB 303	I-35W SB	Link(4002,4003)	4710	72	14	B	10
	SB 304	I-35W SB	Link(4003,4004)	4320	74	12	B	15
	SB 305	Exit to 76th Street	Link(4003,4006)	391	37	11	A	49
	SB 306	I-35W SB	Link(4004,4009)	3019	74	14	B	28
	SB 307	Exit to I-494	Link(4004,4007)	1296	73	9	A	15
	SB 308	To I-494 WB	Link(4007,2047)	642	73	9	A	12
	SB 309	To I-494 EB	Link(4007,1042)	655	73	9	A	15
	SB 310	From I-494 WB	Link(2046,4009)	817	31	26	C	54
	SB 311	From I-494 EB	Link(1040,4008)	1525	38	20	C	36
	SB 312	Entrance from I-494	Link(4008,4010)	2341	39	26	C	41
	SB 313	I-35W SB	Link(4009,4010)	2473	75	11	B	26
	SB 314	Exit to 82nd Ave	Link(4009,4011)	546	45	11	B	25
	SB 315	I-35W SB	Link(4010,4013)	4815	47	23	C	25
	SB 316	Entrance from 82nd Ave	Link(4011,4013)	531	29	15	B	63
	SB 317	I-35W SB	Link(4013,4014)	5346	44	29	D	24
	SB 318	I-35W SB	Link(4014,4015)	4958	43	38	E	27
		SB 319	Exit to 90th Street	Link(4014,4016)	381	36	11	A

Table 12 Hourly MOEs and LOS for the arterial sections (EBL Road, VISSIM)

			3:00 to 4:00 PM				
			Volume	Speed	Density	LOS	Travel Time
			(vph)	(mph)	(vpmp)		(sec-veh)
Direction	To						
North Ramp	Entry Node	EBL North Ramp	832	20	18		31
	EBL North Ramp	EBL South Ramp	838	27	21		31
	EBL South Ramp	Exit Node	344	12	17		41
South Ramp	Entry Node	EBL South Ramp	243	17	7		31
	EBL South Ramp	EBL North Ramp	188	23	10		19
	EBL North Ramp	Exit Node	460	24	11		39

Table 13 Hourly MOEs and LOS for Intersection Approaches (24th Ave, VISSIM)

Intersection	Directions	Approaches	3:00 to 4:00 PM		
			Volume	Delay	LOS
24th Ave.	EB	L	200	16	B
24th Ave.	EB	R	346	0	A
24th Ave.	NB	L	677	40	D
24th Ave.	NB	R	1318	6	A
24th Ave.	NB	T	359	37	D
24th Ave.	SB	L	227	36	D
24th Ave.	SB	R	292	5	A
24th Ave.	SB	T	197	38	D
24th Ave.	WB	L	1176	21	C
24th Ave.	WB	R	214	0	A

Table 14 Hourly Overall MOEs and LOS for Signalized Intersections (VISSIM)

Intersection	Stop control	3:00 to 4:00 PM		3:15 to 4:15 PM	
		Control dealy	LOS	Control dealy	LOS
		(sec/veh)		(sec/veh)	
24th Ave.	Signal Control	22	C	22	C
34th Ave. N	Signal Control	37	D	36	D
34th Ave. S	Signal Control	23	C	29	C
76th Street E	Signal Control	13	B	14	B
76th Street W	Signal Control	7	A	7	A
82nd Street E	Signal Control	18	B	19	B
82nd Street W	Signal Control	10	A	10	A
East Bush Lake Rd. N	Signal Control	11	B	11	B
East Bush Lake Rd. S	Signal Control	9	A	11	B
France Ave N	Signal Control	84	F	91	F
France Ave S	Signal Control	21	C	26	C
Lyndale Ave.	Signal Control	30	C	27	C
Penn Ave.	Signal Control	12	B	13	B
Portland Ave.	Signal Control	15	B	15	B

Table 15: Summary of Design Adequacy Evaluation Results From AIMSUN and VISSIM

Evaluation Level	Total link considered	At least 2 orders in LOS differences between AIMSUN and VISSIM		Number of links/approaches at LOS F		
		Number	%	AIMSUN	VISSIM	In common
Individual freeway links	131	14	10.7	6	5	1
Individual intersection approaches	105	30	28.6	14	4	4

Table 16 MOEs for the freeway corridors under consideration

MOE	Aggregation Level	AIMSUN				VISSIM				Difference(%)			
		I-494		I-35W		I-494		I-35W		I-494		I-35W	
		EB	WB	NB	SB	EB	WB	NB	SB	EB	WB	NB	SB
Total Travel (Vehicle*Mile)	Mainline	132738	120813	31465	30226	126599	113400	30241	29110	4.6	6.1	3.9	3.7
	Ramps	27096	31232	9495	9315	26374	30521	9767	9089	2.7	2.3	-2.9	2.4
	Arterial sections	27373		5235		29720		5039		-8.6		3.7	
	Entire Corridors	339253		85736		326614		83246		3.7		2.9	
	Entire system	424989				409860				3.6			
Total Travel Time (Vehicle*Hour)	Mainline	2402	2198	485	487	1903	2028	449	497	20.8	7.7	7.6	-2.2
	Ramps	796	1088	223	319	764	1172	233	238	3.9	-7.8	-4.5	25.4
	Arterial sections	2325		338		2173		275		6.5		18.5	
	Entire Corridors	8809		1852		8041		1693		8.7		8.6	
	Entire system	10661				9734				8.7			
Speed (Mile/Hour)	Mainline	65	64	69	69	66	63	67	61	-0.9	1.8	2.7	12.7
	Ramps	41	35	54	51	42	31	54	48	-1.9	12.6	0.7	7.1
	Arterial sections	27		29		17		20		36.7		31.3	
	Entire Corridors	51		60		52		56		2.0		6.7	
	Entire system	54				53				1.9			
Total Delay (Vehicle*Hour)	Mainline	435.0	351.9	26.1	45.7	115.6	491.6	18.7	67.8	73.4	-39.7	28.5	-48.5
	Ramps	130.3	215.2	24.0	93.8	148.8	329.8	34.3	36.2	-14.2	-53.2	-42.9	61.5
	Arterial sections	1479		175.35		1160		108.32		21.6		38.2	
	Entire Corridors	2611.8		365.0		2245.7		265.3		14.0		27.3	
	Entire system	2976.8				2511.0				15.6			
Average Delay (Second/Mile/Vehicle)	Mainline	6.0	6.3	2.0	2.9	3.7	20.4	2.3	9.3	38.1	-225.3	-17.9	-222.3
	Ramps	8.9	17.6	3.5	23.5	23.3	51.6	12.2	16.4	-161.8	-193.6	-253.5	30.3
	Arterial sections	113		39.20		166		113.62		-47.3		-189.8	
	Entire Corridors	19.9		8.8		37.9		19.9		90.5		126.1	
	Entire system	17.5				33.8				-93.1			
Total Number of Stops (Stops/Mile/Vehicle)	Mainline	93100	92264	1614	5401	918	113302	918	2233	99.0	-22.8	43.1	58.6
	Ramps	28379	38247	2670	15198	32703	74084	32703	11149	-15.2	-93.7	-1124.9	26.6
	Arterial sections	238172		26653		140055		13335		41.2		50.0	
	Entire Corridors	490163		51535		361062		60338		26.3		17.1	
	Entire system	541698				421401				22.2			
Average Number of Stops (Stops/Mile/Vehicle)	Mainline	0.31	0.44	0.04	0.17	0.01	1.18	0.01	0.08	97.4	-165.0	80.0	49.6
	Ramps	0.76	1.88	0.12	1.42	1.52	2.82	1.57	1.65	-99.5	-49.7	-1233.1	-16.6
	Arterial sections	5.39		1.84		5.43		3.56		-0.8		-93.3	
	Entire Corridors	1.21		0.45		1.59		0.70		31.4		55.6	
	Entire system	1.05				1.39				-32.4			

Table 17 Intersection Delays and LOS

Intersection Name	AIMSUN		VISSIM		SYNCHRO(Peak Hour)
	Control Delay(s)	LOS	Control Delay(s)	LOS	LOS
24th Ave.	18	B	49	D	C
34th Ave. N	35	D	27	C	C
34th Ave. S	78	E	32	C	D
76th Street E	19	B	19	B	B
76th Street W	19	B	10	A	A
82nd Street E	14	B	6	A	D
82nd Street W	30	C	9	A	B
East Bush Lake Rd. N	11	B	20	B	B
East Bush Lake Rd. S	10	B	26	C	A
France Ave N	133	F	109	F	F
France Ave S	35	D	21	C	B
Lyndale Ave.	31	C	23	C	C
Penn Ave.	29	C	17	B	B
Portland Ave.	18	B	15	B	C

APPENDIX A: Presentation

Slide 1

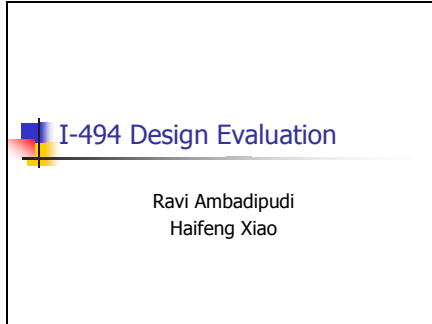

I-494 Design Evaluation

Ravi Ambadipudi
Haifeng Xiao

Slide 1 content: A presentation slide with a white background and a black border. On the left side, there is a decorative graphic consisting of overlapping colored squares (blue, yellow, red) and a black crosshair. To the right of this graphic, the title "I-494 Design Evaluation" is written in blue text. Below the title, the names "Ravi Ambadipudi" and "Haifeng Xiao" are listed in black text, separated by a thin horizontal line.

Slide 2

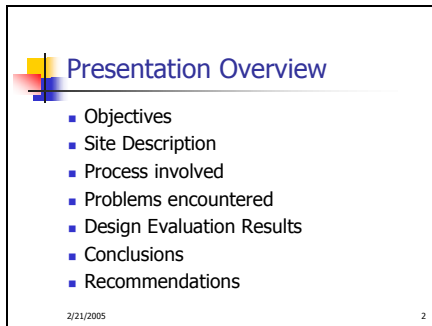

Presentation Overview

- Objectives
- Site Description
- Process involved
- Problems encountered
- Design Evaluation Results
- Conclusions
- Recommendations

2/21/2005 2

Slide 2 content: A presentation slide with a white background and a black border. On the left side, there is a decorative graphic consisting of overlapping colored squares (blue, yellow, red) and a black crosshair. To the right of this graphic, the title "Presentation Overview" is written in blue text. Below the title, a bulleted list of seven items is shown in black text, each preceded by a blue square bullet point. At the bottom left of the slide, the date "2/21/2005" is written in small black text, and at the bottom right, the number "2" is written in small black text.

Slide 3

Objectives

- Determine Volumes, Travel Times, Delays and LOS for each section in the network
- Determine control delays for signalized intersections
- Compare results with both AIMSUN and VISSIM

2/21/2005 3

Slide 4

Site Description

- Site being redesigned is an 8-mile section of the I-494 corridor
 - I-494 spanning in the East-West direction
 - I-35W spanning in the North-South direction
 - 11 signalized intersections
- Of the 11 signalized intersections 4 are single point urban interchanges (SPUI).
- Most freeway sections of the test site consist of five lanes
- There are seven weaving sections in the entire site
- Distinguishing features of the proposed design
 - CD roads instead of cloverleaf sections on the freeways
 - SPUI instead of diamond interchanges on the arterials

2/21/2005 4

Slide 5

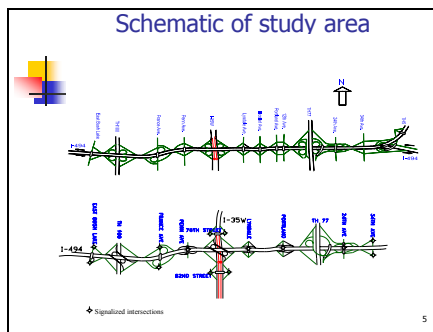

Slide 6

Process Involved

- AIMSUN and VISSIM calibrated with existing conditions
- For 2017 scenario:
 - Data Collection
 - Geometry (Provided : MnDOT)
 - Demand Data (Estimated : Ravi)
 - Control Plans (Provided : URS)
 - Geometry Coding: AIMSUN and VISSIM
 - Demand Data Entry (entering volumes, turning proportions): Manual, labor intensive

2/21/2005 6

Slide 7

Process Involved.....contd

- Signal Timing Data Entry
- Simulations : Five Replications
- MOE's Considered: Volume, Travel Time, Delay and LOS on different links of the network, control delay for intersections
- To obtain MOE's:
 - Wrote queries using SQL to convert basic output from AIMSUN and VISSIM in the format required by MnDOT
 - Queries for AIMSUN and VISSIM are different

2/21/2005 7

Slide 8

Formulas for calculating MOE's

--AIMSUN

a. Volumes

$$VOL_{i,p} = \sum_{k=p}^{p+4} Vol_{i,k}$$

$VOL_{i,p}$: volume during p^{th} hour on segment i .
 $Vol_{i,k}$: volume in time interval k on segment i , and can be calculated as following

$$Vol_{i,k} = \frac{\sum_{j=1}^{n_i} vol_{j,k}}{n_i}$$

$Vol_{i,k}$: average volume in time interval k on segment i .
 $vol_{j,k}$: volume in time interval k on the j^{th} section of segment i .
 n_i : the number of sections that segment i has.

2/21/2005 8

Slide 9

**Formulas for calculating MOE's
--AIMSUN**

b. Speeds

$$SPEED_{i,p} = \frac{\sum_{k=1}^{n_i} Vol_{i,k} \cdot Speed_{i,k}}{\sum_{k=1}^{n_i} Vol_{i,k}}$$

SPEED_{i,p}: average speed during pth hour on segment i.
VOL_{i,k}: average volume in time interval k on segment i, and calculated as previously.
SPEED_{i,k}: average speed in time interval k on segment i, can be calculated as following:

$$Speed_{i,k} = \frac{\sum_{j=1}^{n_i} vol_{i,j,k} \cdot speed_{i,j,k}}{\sum_{j=1}^{n_i} vol_{i,j,k}}$$

Speed_{i,k}: average speed in time interval k on segment i.
vol_{i,j,k}: volume in time interval k on the jth section of segment i.
speed_{i,j,k}: average speed in time interval k on the jth section of segment i.
n_i: the number of sections that segment i has.

2/21/2005 9

Slide 10

**Formulas for calculating MOE's
--AIMSUN**

c. Densities

$$DENSITY_{i,p} = \frac{\sum_{k=1}^{n_i} Vol_{i,k} \cdot Density_{i,k}}{\sum_{k=1}^{n_i} Vol_{i,k}}$$

DENSITY_{i,p}: average density during pth hour on segment i.
VOL_{i,k}: volume in time interval k on segment i, and calculated as previously.
DENSITY_{i,k}: average density in time interval k on segment i, can be calculated as following:

$$Density_{i,k} = \frac{\sum_{j=1}^{n_i} vol_{i,j,k} \cdot density_{i,j,k}}{\sum_{j=1}^{n_i} vol_{i,j,k}}$$

Density_{i,k}: average density in time interval k on segment i.
vol_{i,j,k}: volume in time interval k on the jth section of segment i.
density_{i,j,k}: average density in time interval k on the jth section of segment i.
n_i: the number of sections that segment i has.

2/21/2005 10

Slide 11

**Formulas for calculating MOE's
--AIMSUN**

d. Travel times

$$TRAVEL_{i,p} = \frac{\sum_{k=1}^{n_i} Vol_{i,k} \cdot Travel_{i,k}}{\sum_{k=1}^{n_i} Vol_{i,k}}$$

TRAVEL_{i,p}: average travel time per vehicle during pth hour on segment i.
VOL_{i,k}: volume in time interval k on segment i, and calculated as previously.
TRAVEL_{i,k}: average travel time in time interval k on segment i, can be calculated as following:

$$Travel_{i,k} = \frac{\sum_{j=1}^{n_i} travel_{i,j,k}}{n_i}$$

Travel_{i,k}: average travel time in time interval k on segment i.
travel_{i,j,k}: average travel time in time interval k on the jth section of segment i.

2/21/2005 11

Slide 12

Formulas for calculating MOE's
--AIMSUN

e. Intersection delays

$$D = \frac{\sum_i d_i \cdot V_i}{\sum_i V_i}$$

D: intersection overall delay.
 V_i : through volume at direction i.
 d_i : average delay in direction i, and calculated as follows.

$$d_i = \frac{\sum_j d_{i,j} \cdot V_{i,j}}{\sum_j V_{i,j}}$$

d_i : Average delay in direction i.
 $d_{i,j}$: Average delay at (stream) approach j in direction i.
 $V_{i,j}$: Volume at (stream) approach j in direction i.

2/21/2005 12

Slide 13

Formulas for calculating MOE's
--VISSIM

a. Volumes

$$VOL_{i,p} = \sum_{k=p}^{p+4} Vol_{i,k}$$

$VOL_{i,p}$: volume during pth hour on travel time section (segment) i.
 $Vol_{i,k}$: volume in time interval k on travel time section (segment) i.

2/21/2005 13

Slide 14

Formulas for calculating MOE's
--VISSIM

b. Speeds

$$SPEED_{i,p} = \frac{\sum_{k=p}^{p+4} Vol_{i,k} \cdot Speed_{i,k}}{\sum_{k=p}^{p+4} Vol_{i,k}}$$

$SPEED_{i,p}$: average speed during pth hour on travel time section (segment) i.
 $Vol_{i,k}$: volume in time interval k on travel time section (segment) i.
 $Speed_{i,k}$: average speed in time interval k on travel time section (segment) i, can be calculated as following:

$$Speed_{i,k} = \frac{Dis \tan ce_i}{Travel_{i,k}}$$

$Speed_{i,k}$: average speed in time interval k on travel time section (segment) i.
 $Travel_{i,k}$: average travel time in time interval k on travel time section (segment) i.
 $Distance_i$: the distance of travel time section (segment) i.

2/21/2005 14

Slide 15

Formulas for calculating MOE's --VISSIM

C. Travel times

$$TRAVEL_{L,p} = \frac{\sum_{k=1}^{24} Vol_{L,k} \cdot Travel_{L,k}}{\sum_{k=1}^{24} Vol_{L,k}}$$

TRAVEL_{L,p}: average travel time per vehicle during pth hour on travel time section (segment) L.
 Vol_{L,k}: volume in time interval k on travel time section (segment) L.
 Travel_{L,k}: average travel time in time interval k on travel time section (segment) L.

2/21/2005 15

Slide 16

Problems Encountered

- Demand estimation: cumbersome
 - AADT data for different links on the freeway and 15-minute volumes and turning counts at intersections was provided
 - 15-minute volumes/link on freeway sections and ramp sections was estimated from current volumes and AADT data
 - Conservation equation was used to balance the intersection and ramp volumes
- No tools available for data entry
 - Data had to be entered manually (approximately 8000 data points/program)
 - Error prone process: Development of tools is highly desirable

2/21/2005 16

Slide 17

Problems Encountered...contd

- Poor quality of background maps
 - Initial geometries built in AIMSUN/VISSIM did not match
 - Changes had to be made by looking at roll prints
- MOE's not available in the format requested by MnDOT
 - Queries had to be written (time consuming)
- VISSIM in general required more effort
- Considerably more time/effort required to complete the project
 - 3 months delay
 - 100% overtime (Not budgeted for)

2/21/2005 17

Slide 18

Design Evaluation Results

- MOE's for:
 - Freeway mainline segments and ramps
 - Intersection approaches by movement
 - System-wide measures
 - Intersection control delays

2/21/2005 18

Slide 19

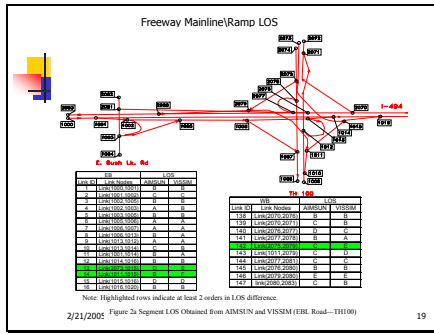

Slide 20

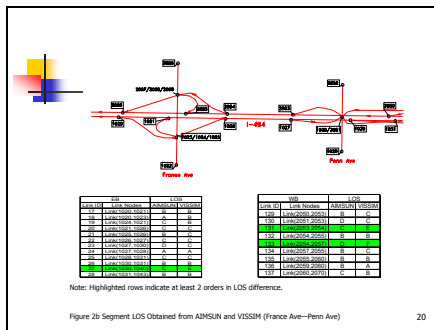

Slide 21

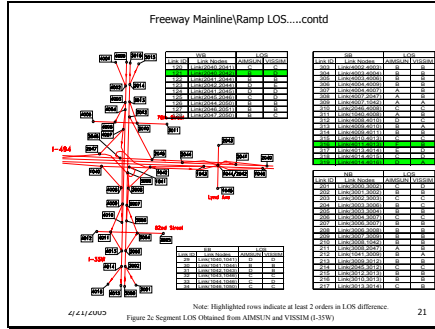

Slide 22

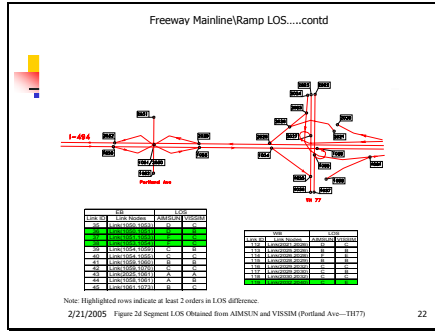

Slide 23

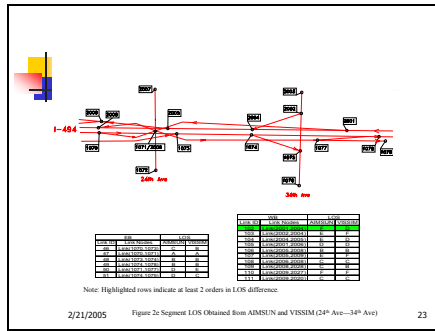

Slide 24

**Results: Intersection LOS
(EBL Road, France Ave, Penn Ave)**



Intersection	Direction	Approach	LOS	
			PERFORMANCE	SYSTEM
EBL Road/Lake St	EBL	T	A	B
	EBL	R	A	A
	EBL	L	A	A
Lake St/EBL	EBL	R	A	A
	EBL	T	A	A
	EBL	L	A	A
France Ave/S	S	T	A	A
	S	R	A	A
	S	L	A	A
Penn Ave/S	S	T	A	A
	S	R	A	A
	S	L	A	A

Intersection	Direction	Approach	LOS	
			PERFORMANCE	SYSTEM
Lake St/EBL	EBL	R	A	A
	EBL	T	A	A
	EBL	L	A	A
France Ave/S	S	T	A	A
	S	R	A	A
	S	L	A	A
Penn Ave/S	S	T	A	A
	S	R	A	A
	S	L	A	A

Intersection	Direction	Approach	LOS	
			PERFORMANCE	SYSTEM
Penn Ave/S	S	T	A	A
	S	R	A	A
	S	L	A	A
France Ave/S	S	T	A	A
	S	R	A	A
	S	L	A	A
Lake St/EBL	EBL	R	A	A
	EBL	T	A	A
	EBL	L	A	A

24

Slide 25

**Results: Intersection LOS
(76th Street, 82nd Street, Lyndale Ave)**



Intersection	Direction	Approach	LOS	
			PERFORMANCE	SYSTEM
76th Street/S	S	L	A	B
	S	R	A	A
	S	T	A	A
82nd Street/S	S	L	A	B
	S	R	A	A
	S	T	A	A
Lyndale Ave/S	S	L	A	A
	S	R	A	A
	S	T	A	A

Intersection	Direction	Approach	LOS	
			PERFORMANCE	SYSTEM
76th Street/S	S	L	A	B
	S	R	A	A
	S	T	A	A
82nd Street/S	S	L	A	B
	S	R	A	A
	S	T	A	A
Lyndale Ave/S	S	L	A	A
	S	R	A	A
	S	T	A	A

Intersection	Direction	Approach	LOS	
			PERFORMANCE	SYSTEM
76th Street/S	S	L	A	B
	S	R	A	A
	S	T	A	A
82nd Street/S	S	L	A	B
	S	R	A	A
	S	T	A	A
Lyndale Ave/S	S	L	A	A
	S	R	A	A
	S	T	A	A

25

Slide 26

**Results: Intersection LOS
(Portland Ave, 24th Ave, 34th Ave)**



Intersection	Direction	Approach	LOS	
			PERFORMANCE	SYSTEM
Portland Ave/S	S	L	A	B
	S	R	A	A
	S	T	A	A
24th Ave/S	S	L	A	B
	S	R	A	A
	S	T	A	A
34th Ave/S	S	L	A	B
	S	R	A	A
	S	T	A	A

Intersection	Direction	Approach	LOS	
			PERFORMANCE	SYSTEM
Portland Ave/S	S	L	A	B
	S	R	A	A
	S	T	A	A
24th Ave/S	S	L	A	B
	S	R	A	A
	S	T	A	A
34th Ave/S	S	L	A	B
	S	R	A	A
	S	T	A	A

Intersection	Direction	Approach	LOS	
			PERFORMANCE	SYSTEM
Portland Ave/S	S	L	A	B
	S	R	A	A
	S	T	A	A
24th Ave/S	S	L	A	B
	S	R	A	A
	S	T	A	A
34th Ave/S	S	L	A	B
	S	R	A	A
	S	T	A	A

2/21/2005 26

Slide 27

Results: System-wide MOE's

MOE	Aggregation Level	AIMSUN			VISSIM			VISSIM/2010/Urban Inter		
		1st	2nd	3rd	1st	2nd	3rd	1st	2nd	3rd
Total Travel (Vehicle/Min)	Simulation	4751	4702	4702	4751	4702	4702	4751	4702	4702
	AIMSUN	4751	4702	4702	4751	4702	4702	4751	4702	4702
	VISSIM	4751	4702	4702	4751	4702	4702	4751	4702	4702
	VISSIM/2010/Urban Inter	4751	4702	4702	4751	4702	4702	4751	4702	4702
Total Travel Time (Vehicle/Min)	Simulation	2282	2195	2195	2282	2195	2195	2282	2195	2195
	AIMSUN	2282	2195	2195	2282	2195	2195	2282	2195	2195
	VISSIM	2282	2195	2195	2282	2195	2195	2282	2195	2195
	VISSIM/2010/Urban Inter	2282	2195	2195	2282	2195	2195	2282	2195	2195
Speed (Mile/Hour)	Simulation	41	42	42	41	42	42	41	42	42
	AIMSUN	41	42	42	41	42	42	41	42	42
	VISSIM	41	42	42	41	42	42	41	42	42
	VISSIM/2010/Urban Inter	41	42	42	41	42	42	41	42	42
Total Delay (Vehicle/Min)	Simulation	1533	1533	1533	1533	1533	1533	1533	1533	1533
	AIMSUN	1533	1533	1533	1533	1533	1533	1533	1533	1533
	VISSIM	1533	1533	1533	1533	1533	1533	1533	1533	1533
	VISSIM/2010/Urban Inter	1533	1533	1533	1533	1533	1533	1533	1533	1533
Average Delay (Seconds/Mile/Vehicle)	Simulation	11	11	11	11	11	11	11	11	11
	AIMSUN	11	11	11	11	11	11	11	11	11
	VISSIM	11	11	11	11	11	11	11	11	11
	VISSIM/2010/Urban Inter	11	11	11	11	11	11	11	11	11
Total Number of Stops (Stops/Mile/Vehicle)	Simulation	11	11	11	11	11	11	11	11	11
	AIMSUN	11	11	11	11	11	11	11	11	11
	VISSIM	11	11	11	11	11	11	11	11	11
	VISSIM/2010/Urban Inter	11	11	11	11	11	11	11	11	11
Average Number of Stops (Stops/Mile/Vehicle)	Simulation	0.33	0.33	0.33	0.33	0.33	0.33	0.33	0.33	0.33
	AIMSUN	0.33	0.33	0.33	0.33	0.33	0.33	0.33	0.33	0.33
	VISSIM	0.33	0.33	0.33	0.33	0.33	0.33	0.33	0.33	0.33
	VISSIM/2010/Urban Inter	0.33	0.33	0.33	0.33	0.33	0.33	0.33	0.33	0.33

Slide 28

Results: Average Intersection Delay

Intersection Name	AIMSUN			VISSIM			VISSIM/2010/Urban Inter		
	Control	Delay	LOS	Control	Delay	LOS	Control	Delay	LOS
25th Ave. N	35	D	27	C	C				
70th Street E	19	B	19	B	B				
70th Street W	19	B	19	A	A				
32nd Street E	14	B	6	A	D				
East South Lake Blvd. N	11	B	20	B	B				
East South Lake Blvd. W	10	B	20	C	B				
Lawrence Ave. N	133	F	109	F	F				
Lincoln Ave. S	10	D	21	C	B				
Lincoln Ave. W	10	D	17	C	B				
Shore Ave.	20	D	17	B	B				
Woodland Ave.	14	B	14	B	C				

2/21/2005 28

Slide 29

- ### Conclusions
- Basic MOEs like volumes, speed, density and travel time are similar with both models
 - Substantial differences between the two models for total delay and total number of stops
 - Reasons for discrepancies:
 - Mostly due to a difference in definition of some measure
 - Local parameter calibration is impossible for future conditions
 - Note that after calibration both simulators produced similar accuracy when current conditions are simulated
- 2/21/2005 29

Slide 30



Recommendations

- Planning models should be used to generate 15 minute volume data on different links (instead of AADT)
- Process of balancing volumes on intersections and ramps should be automated
- Automation of data entry into simulators is highly desirable
- Exact location of lane drop sections is necessary (better background maps in general)

2/21/2005 30